



***Mars Atmosphere and Volatile Evolution  
(MAVEN) Mission***

***Solar Energetic Particle (SEP) Instrument***

**PDS Archive**

**Software Interface Specification**

06/24/2014

Prepared by

Rob Lillis, Davin Larson,  
([rlillis@ssl.berkeley.edu](mailto:rlillis@ssl.berkeley.edu), [davin@ssl.berkeley.edu](mailto:davin@ssl.berkeley.edu).)

**MAVEN**  
**Solar Energetic Particle (SEP) Instrument**

**PDS Archive**  
**Software Interface Specification**

Custodian:

**Davin  
Larson**

 Digitally signed by Davin Larson  
DN: cn=Davin Larson, o=SSL, ou,  
email=davin@ssl.berkeley.edu,  
c=US  
Date: 2014.06.27 11:02:05 -08'00'

\_\_\_\_\_  
Davin E. Larson  
SEP Instrument Lead

\_\_\_\_\_  
Date

Approved:

 Digitally signed by Robert Lillis  
DN: cn=Robert Lillis, o=UC Berkeley,  
ou=Space Science Lab,  
email=rlillis@ssl.berkeley.edu, c=US  
Date: 2014.07.08 12:52:38 -07'00'

\_\_\_\_\_  
Robert J Lillis  
SEP Deputy Instrument Lead

\_\_\_\_\_  
Date

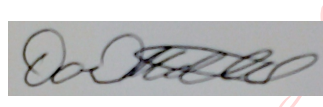
 Digitally signed by David L. Mitchell  
DN: cn=David L. Mitchell, o, ou=UCB SSL,  
email=mitchell@ssl.berkeley.edu, c=US  
Date: 2014.07.08 11:08:23 -08'00'

\_\_\_\_\_  
David L. Mitchell  
MAVEN Science Data Working Group Lead

\_\_\_\_\_  
Date

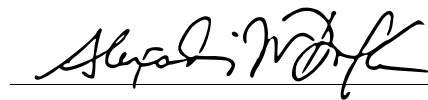
\_\_\_\_\_  
Alexandria DeWolfe  
MAVEN Science Data Center

\_\_\_\_\_  
July 9, 2014  
Date

---

Raymond J. Walker  
PDS PPI Node Manager

---

Date

---

Thomas H. Morgan  
PDS Project Manager

---

Date

## Contents

<b>1</b>	<b>Introduction .....</b>	<b>1</b>
1.1	Distribution List .....	1
1.2	Document Change Log .....	1
1.3	TBD Items .....	1
1.4	Abbreviations .....	1
1.5	Glossary .....	4
1.6	MAVEN Mission Overview .....	6
1.6.1	Mission Objectives.....	6
1.6.2	Payload.....	7
1.7	SIS Content Overview .....	8
1.8	Scope of this document.....	8
1.9	Applicable Documents.....	8
1.10	Audience .....	8
<b>2</b>	<b>SEP Instrument Description .....</b>	<b>9</b>
2.1	Science Objectives .....	12
2.2	Instrument configuration and Detectors.....	12
2.3	Detector signal processing .....	13
2.4	Detector Response and Calibration.....	14
2.4.1	Absolute energy calibration .....	15
2.4.2	Ion energy and detector dead layer calibration .....	15
2.4.3	SEP electron calibration.....	16
	16	
2.4.4	Deconvolution of electron and ion spectra .....	17
2.5	Measured Parameters .....	18
2.6	Operational Modes.....	18
2.7	Operational Considerations.....	18
2.8	In-Flight calibration [TBC].....	19
<b>3</b>	<b>Data Overview .....</b>	<b>20</b>
3.1	Data Reduction Levels .....	20

3.2	Products.....	21
3.3	Product Organization .....	21
3.3.1	Collection and Basic Product Types .....	22
3.4	Bundle Products .....	23
3.5	Data Flow .....	23
<b>4</b>	<b>Archive Generation .....</b>	<b>25</b>
4.1	Data Processing and Production Pipeline .....	25
4.1.1	Reduced Data Production Pipeline .....	25
4.1.2	Calibrated Data Production Pipeline.....	25
4.1.3	Ancillary Data Production Pipeline .....	26
4.2	Data Validation .....	26
4.2.1	Instrument Team Validation .....	26
4.2.2	MAVEN Science Team Validation .....	26
4.2.3	PDS Peer Review.....	26
4.3	Data Transfer Methods and Delivery Schedule .....	27
4.4	Data Product and Archive Volume Size Estimates.....	28
4.5	Data Validation .....	29
4.6	Backups and duplicates .....	29
<b>5</b>	<b>Archive organization and naming.....</b>	<b>30</b>
5.1	Logical Identifiers .....	30
5.1.1	LID Formation .....	30
5.1.2	VID Formation.....	31
5.2	SEP Archive Contents.....	31
5.2.1	SEP Reduced (MAVEN Level 1) Science Data Bundle.....	31
5.2.2	SEP Calibrated (MAVEN Level 2) Science Data Bundle .....	31
5.2.3	SEP Ancillary (MAVEN Level 2) Science Data Bundle.....	32
5.3	Document Collection .....	32
<b>6</b>	<b>Archive products formats.....</b>	<b>34</b>
6.1	Data File Formats.....	34
6.1.1	Reduced data file structure.....	34
6.1.2	Calibrated data file structure .....	<b>Error! Bookmark not defined.</b>
6.1.3	Ancillary data file structure .....	39
6.2	Document Product File Formats .....	43

6.3	PDS Labels.....	43
6.3.1	XML Documents .....	43
6.4	Delivery Package .....	43
6.4.1	The Package .....	43
6.4.2	Transfer Manifest.....	43
6.4.3	Checksum Manifest .....	44
<b>Appendix A</b>	<b>Support staff and cognizant persons.....</b>	<b>45</b>
<b>Appendix B</b>	<b>Naming conventions for MAVEN science data files.....</b>	<b>46</b>
<b>Appendix C</b>	<b>Sample Bundle Product Label.....</b>	<b>48</b>
<b>Appendix D</b>	<b>Sample Collection Product Label.....</b>	<b>49</b>
<b>Appendix E</b>	<b>Sample Data Product Labels .....</b>	<b>50</b>
<b>Appendix F</b>	<b>PDS Delivery Package Manifest File Record Structures .....</b>	<b>51</b>
F.1	Transfer Package Directory Structure.....	51
F.2	Transfer Manifest Record Structure.....	51
F.3	Checksum Manifest Record Structure .....	51

## List of Figures

Figure 1:	The SEP instrument (top) and its location and fields of view on the spacecraft. The red aperture covers are to be removed before flight. ....	11
Figure 4:	A graphical depiction of the relationship among bundles, collections, and basic products.....	22
Figure 5:	MAVEN Ground Data System responsibilities and data flow. Note that this figure includes portions of the MAVEN GDS which are not directly connected with archiving, and are therefore not described in Section 3.5 above. ....	24
Figure 6:	Duplication and dissemination of SEP archive products at PDS/PPI. ....	29

## List of Tables

Table 1:	Distribution list.....	1
Table 2:	Document change log .....	1
Table 3:	List of TBD items .....	1
Table 4:	Abbreviations and their meaning.....	1
Table 5:	Data reduction level designations.....	20

Table 6: Collection product types .....	22
<i>Table 7: SEP Bundles</i> .....	<b>Error! Bookmark not defined.</b>
Table 8: MAVEN PDS review schedule .....	26
Table 9: Archive bundle delivery schedule .....	27
Table 10: SEP.l0 Level 0 Raw Data Collections .....	<b>Error! Bookmark not defined.</b>
Table 11: SEP.calibrated Level 2 Science Data Collections .....	31
Table 12: Raw data file data record structure .....	<b>Error! Bookmark not defined.</b>
Table 13: Calibrated data file data record structure.....	34
Table 14. XML documents for the MAVEN SEP PDS archive. ....	<b>Error! Bookmark not defined.</b>
Table 15: Archive support staff .....	45

## 1 Introduction

This software interface specification (SIS) describes the format and content of the Solar Energetic Particle Instrument (SEP) Planetary Data System (PDS) data archive. It includes descriptions of the data products and associated metadata, and the archive format, content, and generation pipeline.

### 1.1 Distribution List

Table 1: Distribution list

Name	Organization	Email
Davin E. Larson	UCB/SSL	davin@ssl.berkeley.edu
Robert J. Lillis	UCB/SSL	rlillis@ssl.berkeley.edu
Dave Mitchell	UCB/SSL	mitchell@ssl.berkeley.edu
Alexandria DeWolfe	LASP/SDC	alex.dewolfe@lasp.colorado.edu
Steve Joy	UCLA/PDS/PPI	sjoy@igpp.ucla.edu
Ray Walker	UCLA/PDS/PPI	rwalker@igpp.ucla.edu
Joe Mafi	UCLA/PDS/PPI	jmafi@igpp.ucla.edu

### 1.2 Document Change Log

Table 2: Document change log

Version	Change	Date	Affected portion
0.0	Initial template	2012-Aug-24	All
0.1	Updated template	2013-Feb-13	All
0.2	Final template	2013-Feb-15	
0.3	Revised for SEP	2013-Aug-01	All
0.11	Substantial edits	2014-Mar-24	All

### 1.3 TBD Items

Table 3 lists items that are not yet finalized.

Table 3: List of TBD items

Item	Section(s)	Page(s)
Full references for PDS4 Standards Reference, and Data Provider's Handbook documents (to be provided by PDS/PPI)	1.9	
Sample labels (to be provided by PDS/PPI)	Appendices C, D, and E	

### 1.4 Abbreviations

Table 4: Abbreviations and their meaning

Abbreviation	Meaning
--------------	---------



*Solar Energetic Particle Instrument (SEP) Data Product and Archive Volume SIS*

<b>Abbreviation</b>	<b>Meaning</b>
ADC	Analog-Digital Converter (values)
ASCII	American Standard Code for Information Interchange
Atmos	PDS Atmospheres Node (NMSU, Las Cruces, NM)
CCSDS	Consultative Committee for Space Data Systems
CDR	Calibrated Data Record
CFDP	CCSDS File Delivery Protocol
CK	C-matrix Kernel (NAIF orientation data)
CODMAC	Committee on Data Management, Archiving, and Computing
CRC	Cyclic Redundancy Check
CU	University of Colorado (Boulder, CO)
DAP	Data Analysis Product
DDR	Derived Data Record
DMAS	Data Management and Storage
DPF	Data Processing Facility
E&PO	Education and Public Outreach
EDR	Experiment Data Record
EUV	Extreme Ultraviolet; also used for the EUV Monitor, part of LPW (SSL)
FEI	File Exchange Interface
FOV	Field of View
FTP	File Transfer Protocol
GB	Gigabyte(s)
GSFC	Goddard Space Flight Center (Greenbelt, MD)
HK	Housekeeping
HTML	Hypertext Markup Language
ICD	Interface Control Document
IM	Information Model
ISO	International Standards Organization
ITF	Instrument Team Facility
IUVS	Imaging Ultraviolet Spectrograph (LASP)
JPL	Jet Propulsion Laboratory (Pasadena, CA)

<b>Abbreviation</b>	<b>Meaning</b>
LASP	Laboratory for Atmosphere and Space Physics (CU)
LID	Logical Identifier
LIDVID	Versioned Logical Identifier
LPW	Langmuir Probe and Waves instrument (SSL)
MAG	Magnetometer instrument (GSFC)
MAVEN	Mars Atmosphere and Volatile Evolution
MB	Megabyte(s)
MD5	Message-Digest Algorithm 5
MOI	Mars Orbit Insertion
MOS	Mission Operations System
MSA	Mission Support Area
MSE	Mars Solar Ecliptic Coordinate System
NAIF	Navigation and Ancillary Information Facility (JPL)
NASA	National Aeronautics and Space Administration
NGIMS	Neutral Gas and Ion Mass Spectrometer (GSFC)
NMSU	New Mexico State University (Las Cruces, NM)
NSSDC	National Space Science Data Center (GSFC)
PCK	Planetary Constants Kernel (NAIF)
PDS	Planetary Data System
PDS4	Planetary Data System Version 4
PF	Particles and Fields (instruments)
PPI	PDS Planetary Plasma Interactions Node (UCLA)
RS	Remote Sensing (instruments)
SCET	Spacecraft Event Time
SDC	Science Data Center (LASP)
SCLK	Spacecraft Clock
SEP	Solar Energetic Particle instrument (SSL)
SIS	Software Interface Specification
SOC	Science Operations Center (LASP)
SPE	Solar Particle Event

Abbreviation	Meaning
SPICE	Spacecraft, Planet, Instrument, C-matrix, and Events (NAIF data format)
SPK	Spacecraft and Planetary ephemeris Kernel (NAIF)
SSL	Space Sciences Laboratory (UCB)
STATIC	Supra-Thermal And Thermal Ion Composition instrument (SSL)
SWEA	Solar Wind Electron Analyzer (SSL)
SWIA	Solar Wind Ion Analyzer (SSL)
TBC	To Be Confirmed
TBD	To Be Determined
THEMIS	NASA heliophysics mission: ‘Time History of Events and Macroscale Interactions during Substorms’
UCB	University of California, Berkeley
UCLA	University of California, Los Angeles
URN	Uniform Resource Name
UV	Ultraviolet
XML	eXtensible Markup Language

## 1.5 Glossary

**Archive** – A place in which public records or historical documents are preserved; also the material preserved – often used in plural. The term may be capitalized when referring to all of PDS holdings – the PDS Archive.

**Basic Product** – The simplest product in PDS4; one or more data objects (and their description objects), which constitute (typically) a single observation, document, etc. The only PDS4 products that are *not* basic products are collection and bundle products.

**Bundle Product** – A list of related collections. For example, a bundle could list a collection of raw data obtained by an instrument during its mission lifetime, a collection of the calibration products associated with the instrument, and a collection of all documentation relevant to the first two collections.

**Class** – The set of attributes (including a name and identifier) which describes an item defined in the PDS Information Model. A class is generic – a template from which individual items may be constructed.

**Collection Product** – A list of closely related basic products of a single type (e.g. observational data, browse, documents, etc.). A collection is itself a product (because it is simply a list, with its label), but it is not a *basic* product.

**Data Object** – A generic term for an object that is described by a description object. Data objects include both digital and non-digital objects.

**Description Object** – An object that describes another object. As appropriate, it will have structural and descriptive components. In PDS4 a ‘description object’ is a digital object – a string of bits with a predefined structure.

**Digital Object** – An object which consists of real electronically stored (digital) data.

**Identifier** – A unique character string by which a product, object, or other entity may be identified and located. Identifiers can be global, in which case they are unique across all of PDS (and its federation partners). A local identifier must be unique within a label.

**Label** – The aggregation of one or more description objects such that the aggregation describes a single PDS product. In the PDS4 implementation, labels are constructed using XML.

**Logical Identifier (LID)** – An identifier which identifies the set of all versions of a product.

**Versioned Logical Identifier (LIDVID)** – The concatenation of a logical identifier with a version identifier, providing a unique identifier for each version of product.

**Manifest** - A list of contents.

**Metadata** – Data about data – for example, a ‘description object’ contains information (metadata) about an ‘object.’

**Non-Digital Object** – An object which does not consist of digital data. Non-digital objects include both physical objects like instruments, spacecraft, and planets, and non-physical objects like missions, and institutions. Non-digital objects are labeled in PDS in order to define a unique identifier (LID) by which they may be referenced across the system.

**Object** – A single instance of a class defined in the PDS Information Model.

**PDS Information Model** – The set of rules governing the structure and content of PDS metadata. While the Information Model (IM) has been implemented in XML for PDS4, the model itself is implementation independent.

**Product** – One or more tagged objects (digital, non-digital, or both) grouped together and having a single PDS-unique identifier. In the PDS4 implementation, the descriptions are combined into a single XML label. Although it may be possible to locate individual objects within PDS (and to find specific bit strings within digital objects), PDS4 defines ‘products’ to be the smallest granular unit of addressable data within its complete holdings.

**Tagged Object** – An entity categorized by the PDS Information Model, and described by a PDS label.

**Registry** – A data base that provides services for sharing content and metadata.

**Repository** – A place, room, or container where something is deposited or stored (often for safety).

**XML** – eXtensible Markup Language.

**XML schema** – The definition of an XML document, specifying required and optional XML elements, their order, and parent-child relationships.

## 1.6 MAVEN Mission Overview

The MAVEN mission is scheduled to launch on an Atlas V between November 18 and December 7, 2013. After a ten-month ballistic cruise phase, Mars orbit insertion will occur on or after September 22, 2014. Following a 5-week transition phase, the spacecraft will orbit Mars at a 75° inclination, with a 4.5 hour period and periapsis altitude of 140-170 km (density corridor of 0.05-0.15 kg/km<sup>3</sup>). Over a one-Earth-year period, periapsis will precess over a wide range of latitude and local time, while MAVEN obtains detailed measurements of the upper atmosphere, ionosphere, planetary corona, solar wind, interplanetary/Mars magnetic fields, solar EUV and solar energetic particles, thus defining the interactions between the Sun and Mars. MAVEN will explore down to the homopause during a series of five 5-day “deep dip” campaigns for which periapsis will be lowered to an atmospheric density of 2 kg/km<sup>3</sup> (~125 km altitude) in order to sample the transition from the collisional lower atmosphere to the collisionless upper atmosphere. These five campaigns will be interspersed though the mission to sample the subsolar region, the dawn and dusk terminators, the anti-solar region, and the north pole.

### 1.6.1 Mission Objectives

The primary science objectives of the MAVEN project will be to provide a comprehensive picture of the present state of the upper atmosphere and ionosphere of Mars and the processes controlling them and to determine how loss of volatiles to outer space in the present epoch varies with changing solar conditions. Knowing how these processes respond to the Sun’s energy inputs will enable scientists, for the first time, to reliably project processes backward in time to study atmosphere and volatile evolution. MAVEN will deliver definitive answers to high-priority science questions about atmospheric loss (including water) to space that will greatly enhance our understanding of the climate history of Mars. Measurements made by MAVEN will allow us to determine the role that escape to space has played in the evolution of the Mars atmosphere, an essential component of the quest to “follow the water” on Mars. MAVEN will accomplish this by achieving science objectives that answer three key science questions:

- What is the current state of the upper atmosphere and what processes control it?
- What is the escape rate at the present epoch and how does it relate to the controlling processes?
- What has the total loss to space been through time?

MAVEN will achieve these objectives by measuring the structure, composition, and variability of the Martian upper atmosphere, and it will separate the roles of different loss mechanisms for both neutrals and ions. MAVEN will sample all relevant regions of the Martian

atmosphere/ionosphere system—from the termination of the well-mixed portion of the atmosphere (the “homopause”), through the diffusive region and main ionosphere layer, up into the collisionless exosphere, and through the magnetosphere and into the solar wind and downstream tail of the planet where loss of neutrals and ionization occurs to space—at all relevant latitudes and local solar times. To allow a meaningful projection of escape back in time, measurements of escaping species will be made simultaneously with measurements of the energy drivers and the controlling magnetic field over a range of solar conditions. Together with measurements of the isotope ratios of major species, which constrain the net loss to space over time, this approach will allow thorough identification of the role that atmospheric escape plays today and to extrapolate to earlier epochs.

### **1.6.2 Payload**

MAVEN will use the following science instruments to measure the Martian upper atmospheric and ionospheric properties, the magnetic field environment, the solar wind, and solar radiation and particle inputs:

- NGIMS Package:
  - Neutral Gas and Ion Mass Spectrometer (NGIMS) measures the composition, isotope ratios, and scale heights of thermal ions and neutrals.
- RS Package:
  - Imaging Ultraviolet Spectrograph (IUVS) remotely measures UV spectra in four modes: limb scans, planetary mapping, coronal mapping and stellar occultations. These measurements provide the global composition, isotope ratios, and structure of the upper atmosphere, ionosphere, and corona.
- PF Package:
  - Supra-Thermal and Thermal Ion Composition (STATIC) instrument measures the velocity distributions and mass composition of thermal and suprathermal ions from below escape energy to pickup ion energies.
  - Solar Energetic Particle (SEP) instrument measures the energy spectrum and angular distribution of solar energetic electrons (30 keV – 1 MeV) and ions (30 keV – 12 MeV).
  - Solar Wind Ion Analyzer (SWIA) measures solar wind and magnetosheath ion density, temperature, and bulk flow velocity. These measurements are used to determine the charge exchange rate and the solar wind dynamic pressure.
  - Solar Wind Electron Analyzer (SWEA) measures energy and angular distributions of 5 eV to 5 keV solar wind, magnetosheath, and auroral electrons, as well as ionospheric photoelectrons. These measurements are used to constrain the plasma environment, magnetic field topology and electron impact ionization rate.
  - Langmuir Probe and Waves (LPW) instrument measures the electron density and temperature and electric field in the Mars environment. The instrument includes an EUV Monitor that measures the EUV input into Mars atmosphere in three broadband energy channels.
  - Magnetometer (MAG) measures the vector magnetic field in all regions traversed by MAVEN in its orbit.

## 1.7 **SIS Content Overview**

Section 2 describes the Solar Energetic Particle Instrument (SEP) sensor. Section 3 gives an overview of data organization and data flow. Section 4 describes data archive generation, delivery, and validation. Section 5 describes the archive structure and archive production responsibilities. Section 6 describes the file formats used in the archive, including the data product record structures. Individuals involved with generating the archive volumes are listed in 6.2. Appendix B contains a description of the MAVEN science data file naming conventions. Appendix C, Appendix D, and Appendix E contain sample PDS product labels. Appendix F describes SEP archive product PDS deliveries formats and conventions.

## 1.8 **Scope of this document**

The specifications in this SIS apply to all SEP products submitted for archive to the Planetary Data System (PDS), for all phases of the MAVEN mission. This document includes descriptions of archive products that are produced by both the SEP team and by PDS.

## 1.9 **Applicable Documents**

- [1] Planetary Data System Data Provider's Handbook, **TBD**.
- [2] Planetary Data System Standards Reference, Version 1.2.0, March 27, 2014.
- [3] Planetary Science Data Dictionary Document, **TBD**.
- [4] Planetary Data System (PDS) PDS4 Information Model Specification, Version 1.1.0.1.
- [5] Mars Atmosphere and Volatile Evolution (MAVEN) Science Data Management Plan, Rev. C, doc. no.MAVEN-SOPS-PLAN-0068
- [6] Larson, D.E., Lillis, R.J., Hatch, K., Robinson, M., Glaser, D., Dunn, P., Curtis, D.W., 2014. The MAVEN Solar Energetic Particle Investigation. Submitted to Space Science Reviews.
- [7] Archive of MAVEN CDF in PDS4, Version 3, T. King and J. Mafi, March 13, 2014.

## 1.10 **Audience**

This document is useful to those wishing to understand the format and content of the SEP PDS data product archive collection. Typically, these individuals would include scientists, data analysts, and software engineers.

## 2 SEP Instrument Description

The Solar Energetic Particle Instrument (SEP) (see Figure 1, Figure 2) consists of 2 sensors, each consisting of a pair of double-ended solid-state telescopes, measuring electrons and ions over the energy ranges  $\sim 30$ -1000 keV and  $\sim 30$ -12,000 keV/nuc respectively. The SEP sensors are closely based on the Solid State Telescope (SST) sensors on the THEMIS probes and also share significant heritage with the SupraThermal Electron (STE) detectors on STEREO and the SST detectors on the Wind spacecraft.

The SEP sensors are mounted on two corners of the top deck of the spacecraft as shown in Figure 3, positioned to ensure that the fields of view (FOVs) adequately cover the canonical Parker spiral direction (around which solar energetic particle distributions are typically centered), while 1) always avoiding glint from the spacecraft, other sensors and the Articulated Payload Platform (APP) and 2) avoiding direct sunlight during spacecraft attitudes typical of normal science operations.

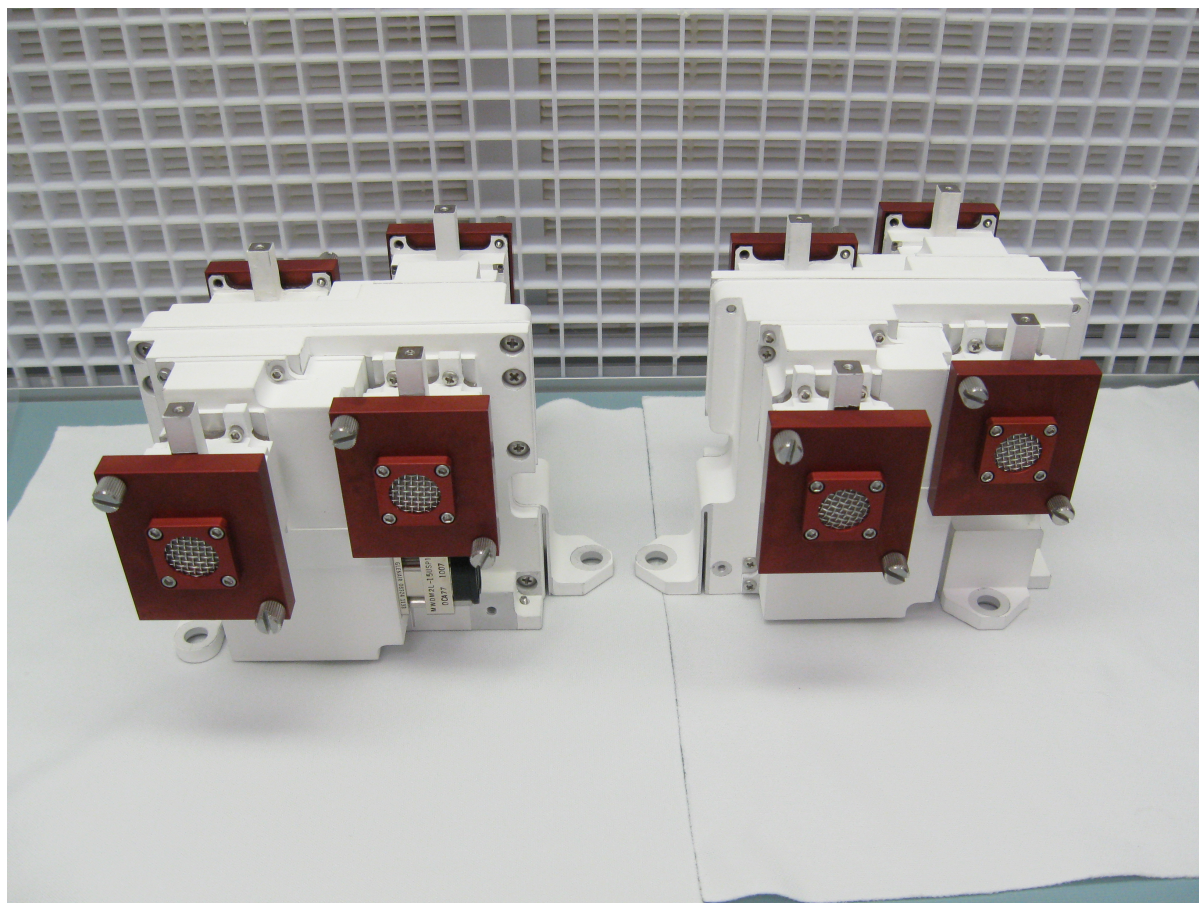

Figure 1: the two identical SEP sensors. The red aperture covers were removed before flight.



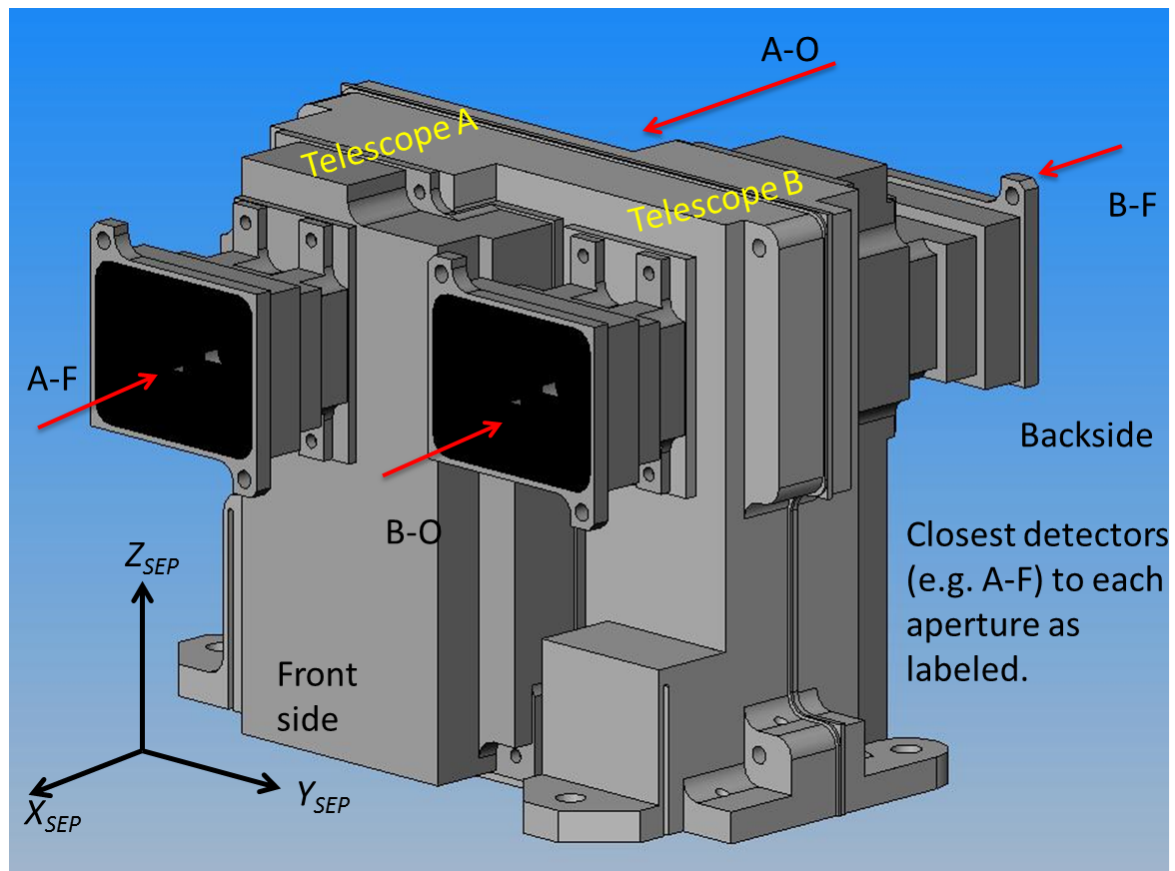
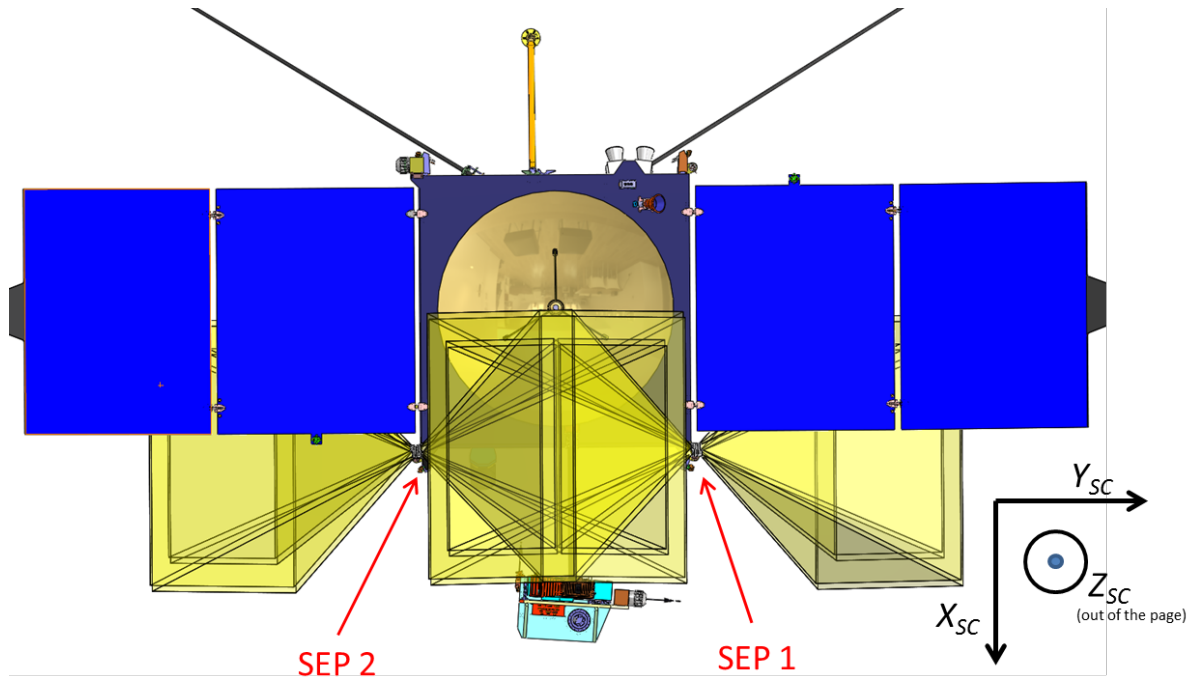

Figure 2: perspective view of SEP sensor identifying (a) particle directions (red arrows), (b) each aperture labeled with the name of the detector facing that aperture, (c) the sensor coordinate system, (d) the telescope identifier (TID) A or ,B and (e) the front and back sides of the sensor.



### SEP FOVs

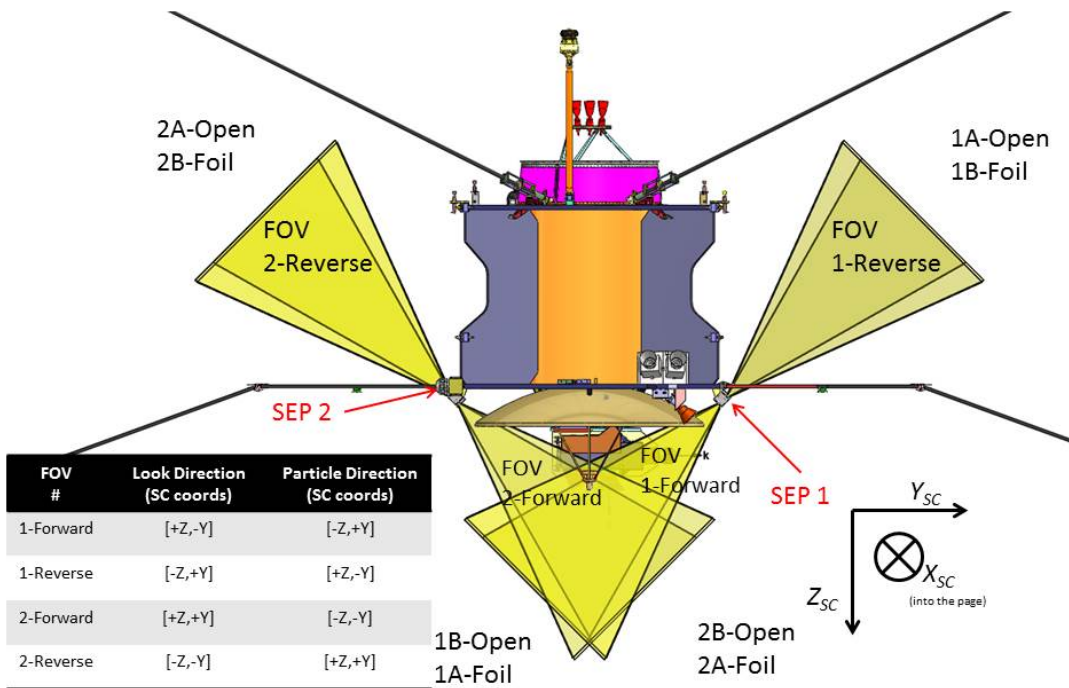

Figure 3: The location and fields of view (FOVs) of the SEP sensors on the spacecraft with the spacecraft coordinate system shown.

## 2.1 Science Objectives

SEP provides measurements that satisfy the MAVEN level 1 requirement to determine solar energetic particles characteristics, 50 keV to 5 MeV protons, with ~1 hr time resolution, energy resolution better than 50% and precision better than 30%.

MAVEN carries a suite of instruments that measure the significant energy inputs into the Martian system and the neutral and charged populations of escaping atmospheric gases, in order to determine how the former drives the latter, with the goal of characterizing the state of the upper atmosphere and its evolution over Mars' history. Within this framework, the main science objective for the SEP instrument is to measure the properties of the energy input to the Martian system from solar energetic particles. As they lose their energy in the atmosphere, precipitating SEPs cause heating, ionization, dissociation and excitation of atmospheric neutrals, thereby substantially affecting atmospheric and ionospheric dynamics and chemistry. Those with energies below ~200 keV deposit energy above the homopause and can therefore directly affect atmospheric escape. Therefore, characterizing SEP fluxes is an important goal of the MAVEN mission.

In order to achieve these science goals, SEP satisfies and in most cases significantly exceeds the following MAVEN Level 3 measurement requirements:

- SEP shall measure energy fluxes from 10 to  $10^6$  eV/[cm<sup>2</sup> s sr eV].
- SEP shall measure ions from 50 keV to 5 MeV.
- SEP shall have energy resolution  $\Delta E/E$  at least 50%
- SEP shall have time resolution of at least 1 hour or better

## 2.2 Instrument configuration and Detectors

The SEP instrument consists of two sensors (SEP 1 and SEP 2), each consisting of a pair of double-ended solid-state telescopes (referred to as 'A' and 'B'). At opposite ends of each telescope exist baffled collimators with identical apertures measuring 42° x 31°. Each telescope consists of a stacked triplet of doped silicon detectors. The outer detectors of the stack are 300 μm thick, while the middle detector consists of two 300 μm detectors wire-bonded together, making an effective thickness of 600 μm. One side of the detector stack is covered with a 2.43 μm Al-Kapton-Al foil to stop ions with energies of < 250 keV/nuc, and is known as the "Foil" side. The 300 μm detector on the "Foil" side of the stack (i.e. closest to the foil) is referred to as the "F" detector. On the other side of the detector stack is a strong magnetic field (~0.25T), created by yoked Sm-Co magnets, to sweep away all electrons with energies <350 keV, and is known as the "Open" side. The 300 μm detector on the "Open" side is known as the "O" detector and is coated with ~900 Å of aluminum to prevent reflected light from sunlit Mars from creating detector noise. The 600 μm middle detector is known as the "Thick" or "T" detector. Each sensor unit has 4 co-moving attenuator paddles with small pinholes which can be rotated into the FOVs of both sides of both detector stacks to reduce particle fluxes by a factor of ~60 and to prevent direct sunlight from damaging the detectors. The yoked magnets are housed in a central magnet cage with oppositely directed magnetic fields for each telescope in order to minimize external DC magnetic fields.

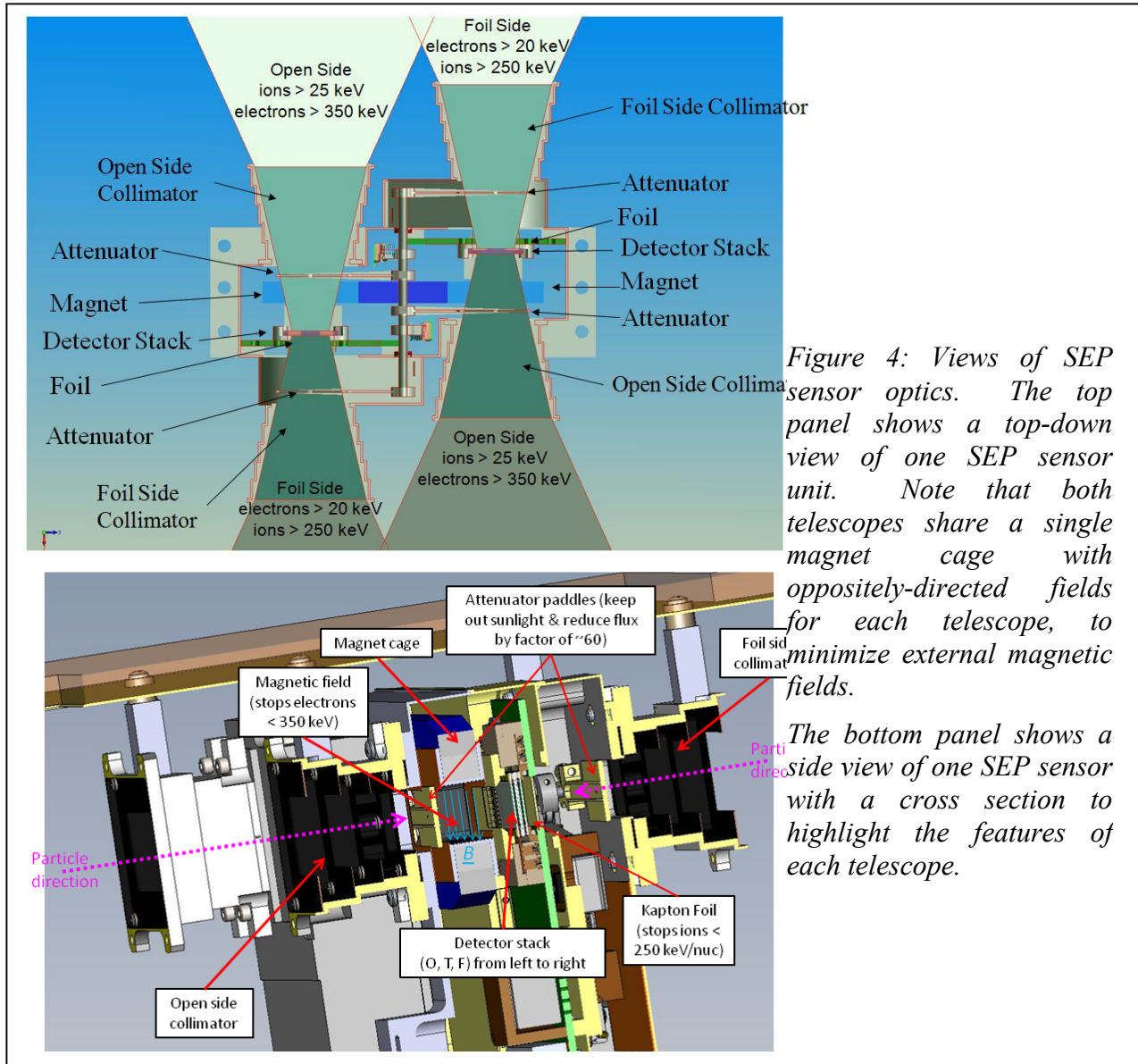

Figure 4: Views of SEP sensor optics. The top panel shows a top-down view of one SEP sensor unit. Note that both telescopes share a single magnet cage with oppositely-directed fields for each telescope, to minimize external magnetic fields.

The bottom panel shows a side view of one SEP sensor with a cross section to highlight the features of each telescope.

### 2.3 Detector signal processing

A charged particle passing through a silicon detector results in the creation of a quantity of electron-hole pairs proportional to the energy deposited. These pairs are accelerated by a ~40V bias potential across the detector and result in a voltage pulse, which is then amplified and shaped. The pulse height is proportional to the energy deposited. All the detectors have depletion layers (or ‘dead’ layers) of a few hundred angstroms thickness at their edges, where no electron-hole pairs are present to record energy deposition.

If an incident particle deposits more than ~11 keV (the electronic noise threshold) in a detector, the voltage pulse is large enough to trigger an ‘event’ and the amount of energy deposited is digitized with a resolution of ~1.5 keV. The SEP sensor characterizes particle events by the

combination of detectors which are triggered (i.e. into which energy is deposited). For example, an 'F' event is one in which the incident particle deposits all its energy in, and hence only triggers, the F detector. An 'FT' event is one in which both F and T detectors are triggered, i.e. the particle passes through (and deposits energy in) the F detector, then deposits more energy and stops in the T detector. The energy and type of each event determines which event counter will be incremented. There are 128 16-bit event counters per telescope, i.e. 256 per SEP sensor. The event type and energy boundaries of each counter (e.g. all F events in the range 20 - 23 keV) are known as the 'energy map'. Energy bins are smaller at low end of the SEP energy range where better resolution is required to characterize energy deposition to the Martian thermosphere.

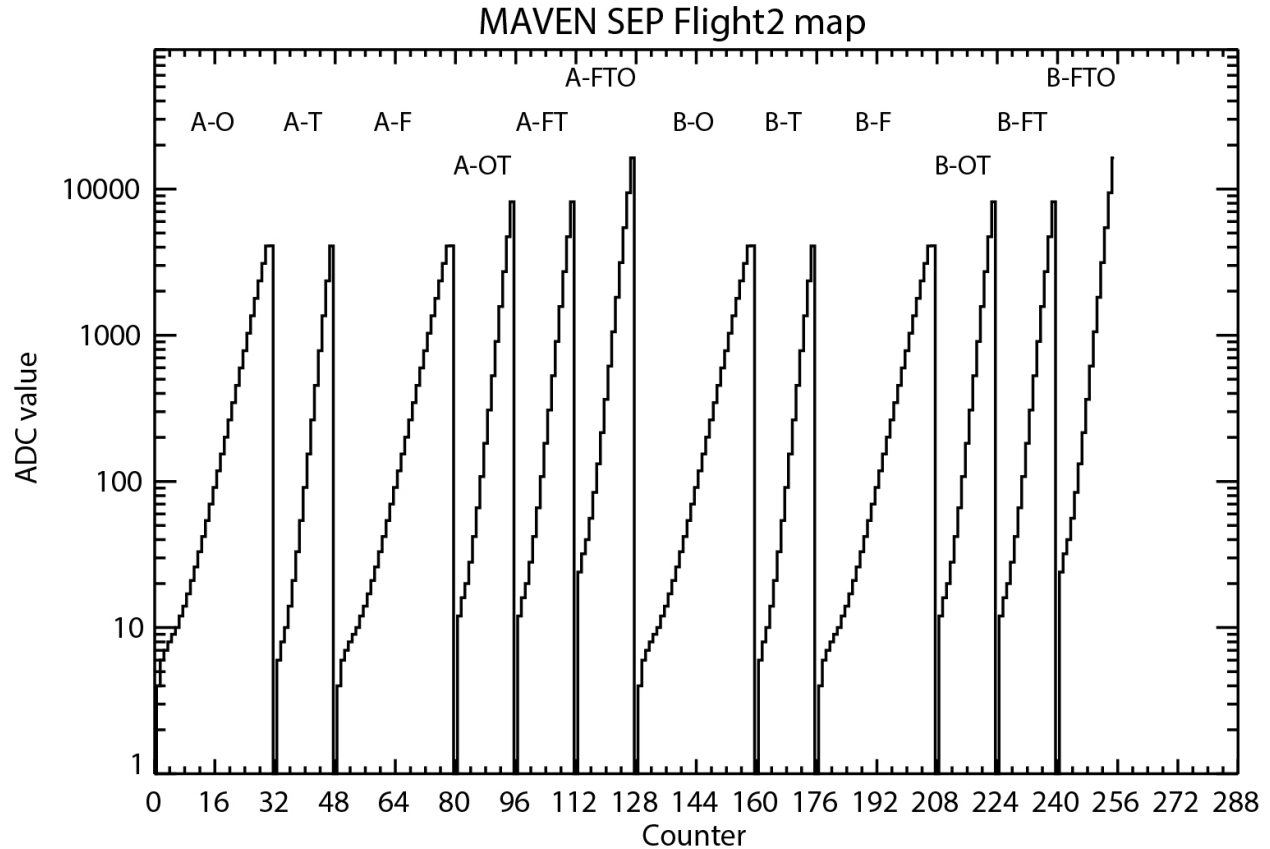

*Figure 5: Example instrument map showing the range of ADC values and event types for each of the 256 counters for each SEP sensor. The conversion from ADC value to particle energy is shown in table 5. This map was used for most of the cruise to Mars.*

The 128 counters are read out via serial interface to the PFDPU every 1 second, where they are summed over the data acquisition interval of 2, 8 or 32 seconds before being packetized and sent to the ground in science data packets (APID 0x70 or 0x71). These arrays of event counters form SEP Level 1 data.

## 2.4 Detector Response and Calibration

On the ground, the aforementioned arrays of event counters must be processed into calibrated ion and electron spectra. This processing requires an accurate instrument calibration, i.e. measuring the detector response to particles of different types with a well-known energy. This calibration requires two distinct steps.

### 2.4.1 Absolute energy calibration

The first step is the absolute energy calibration, i.e. determining the relationship between the energy deposited and the digitized height of the amplified, shaped pulse output by the ADC. This is achieved by measuring the response to x-ray lines whose energies are very well-known, in this case the 59.54 keV line of Americium-241. Unlike charged particles, photons either deposit all their energy in a detector or none, making them ideal for absolute energy calibration. Table 5 shows the number of ADC units per keV for each of the 12 SEP detectors.

Detector	A-F	A-T	A-O	B-F	B-T	B-O
SEP 1	0.690±.025	0.646±.032	0.735±.024	0.711±.024	0.677±.032	0.705±.022
SEP 2	0.738±.026	0.741±.034	0.676±.023	0.705±.023	0.739±.034	0.726±.024

Table 5: number of ADC units per keV for each detector in each of the 2 SEP sensors.

### 2.4.2 Ion energy and detector dead layer calibration

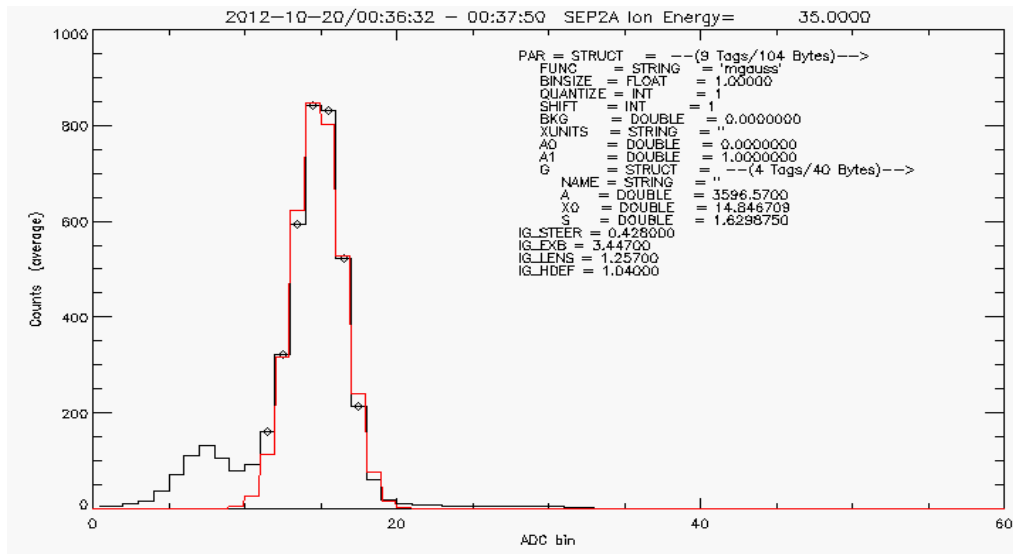

Figure 6: SEP ion calibration example. Counts per second are plotted as a function of ADC value for an ion gun energy of 35 keV for detector SEP 2A.

The second calibration step is to determine the sensor response to charged particles, which can deposit energy in more than one detector and in other parts of the instrument. Since it was not possible to expose the SEP sensor to electrons and ions of all relevant energies (up to 1 MeV for electrons and  $\sim 13$  MeV for protons), it is necessary to compare the charged particle response over a limited energy range with GEANT4 modelling of the detector response to the same range. Ground calibration for ions was performed with an ion gun at fixed energies of 25, 30, 35 and 40keV, an example from which is shown in Figure 6. The purpose of this was to characterize the thickness of the effectively dead layer of Si and Al on each of the four O detectors.

The Al was assumed to be 900Å and the Si was varied in the GEANT4 simulations until a best fit was found. 7 shows the ion response of each of the O detectors, the best fits to the data and the shape of the  $\chi^2$  curves as a function of dead layer thickness. SEP 2A has unexpectedly thick dead layer of 400 Å.

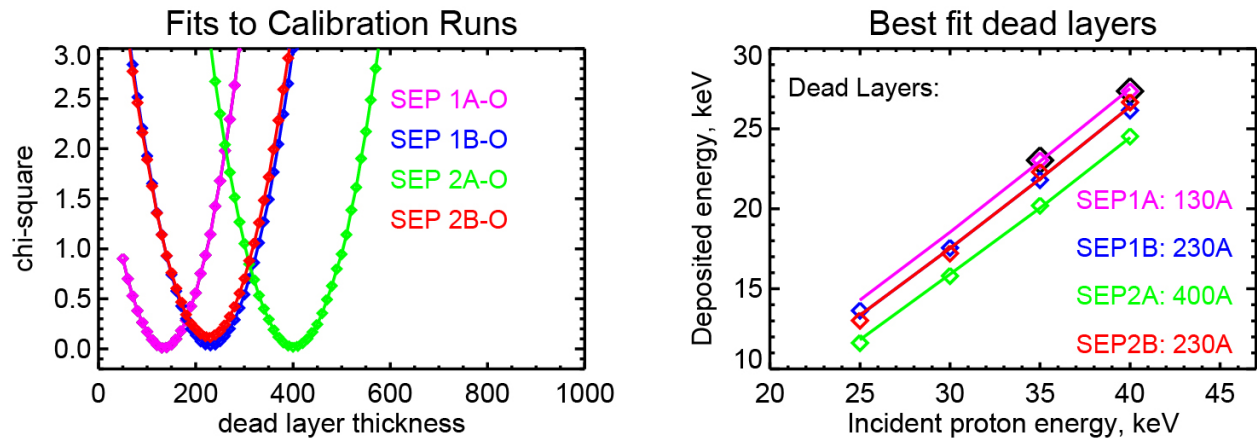

Figure 7: Left panel shows, as unjoined diamonds, the measured deposited versus incident proton energy for the O detectors of each of the SEP detector stacks: 1A-pink, 1B-blue, 2A-green, 2B-red. The solid lines (same colors) are the model results for the silicon dead layer thickness that best fits the measurements. The right panel shows the goodness-of-fit  $\chi^2$  as a function of dead layer thickness with the same color legend.

### 2.4.3 SEP electron calibration

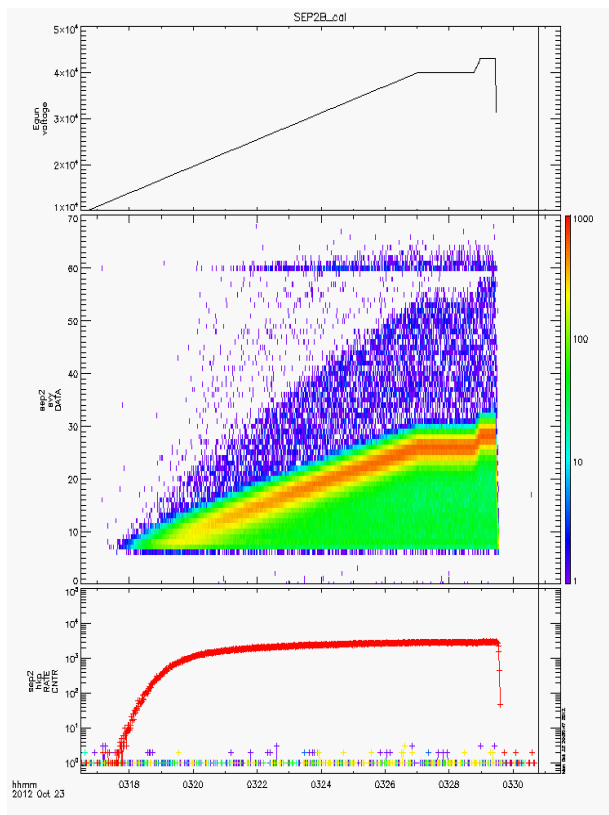

Figure 8: SEP electron ground calibration. The top panel shows electron gun energy in eV. The middle panel shows count rate as a function of time (x-axis) and ADC value (y-axis). The bottom panel shows the total count rate.

The third calibration step is to determine the sensor response to electrons. An electron gun was aimed at the sensor, while the electron energy was slowly turned from 10 keV up to 40 keV. The results are shown in figure 8. The first detectable counts (i.e. energy depositions of ~11 keV or more) begin around for incident electron energies of ~14 keV. Sensitivity to electrons is robust for incident energies above 20 keV.

### 2.4.4 Deconvolution of electron and ion spectra

Knowledge of the dead layer thicknesses of each of the O detectors, along with a detailed of the mechanical structure and material properties, of the sensor, allows accurate modeling of the detector response to a wide range of electron and ion energies via GEANT4. It is particularly important to separate the combined effects of electrons and ions on the same event type (e.g. a 250 keV proton entering the ‘foil side’ collimator loses ~200 keV in the foil and deposits ~50 keV in the F detector, mimicking a 50 keV electron) and to model background counts caused by galactic cosmic rays penetrating the instrument housing.

Even though the electronic noise threshold is ~11 keV, the energy losses mentioned above mean the effective low-energy threshold is ~20 keV for electrons and ~22 keV for ions and varies by detector (see table 5). Figure 9 demonstrates, with a table and associated diagram, the energy ranges and paths of electrons and ions that result in F, FT, O, OT and FTO events. FO events are considered to be 2 simultaneous separate F and O events.

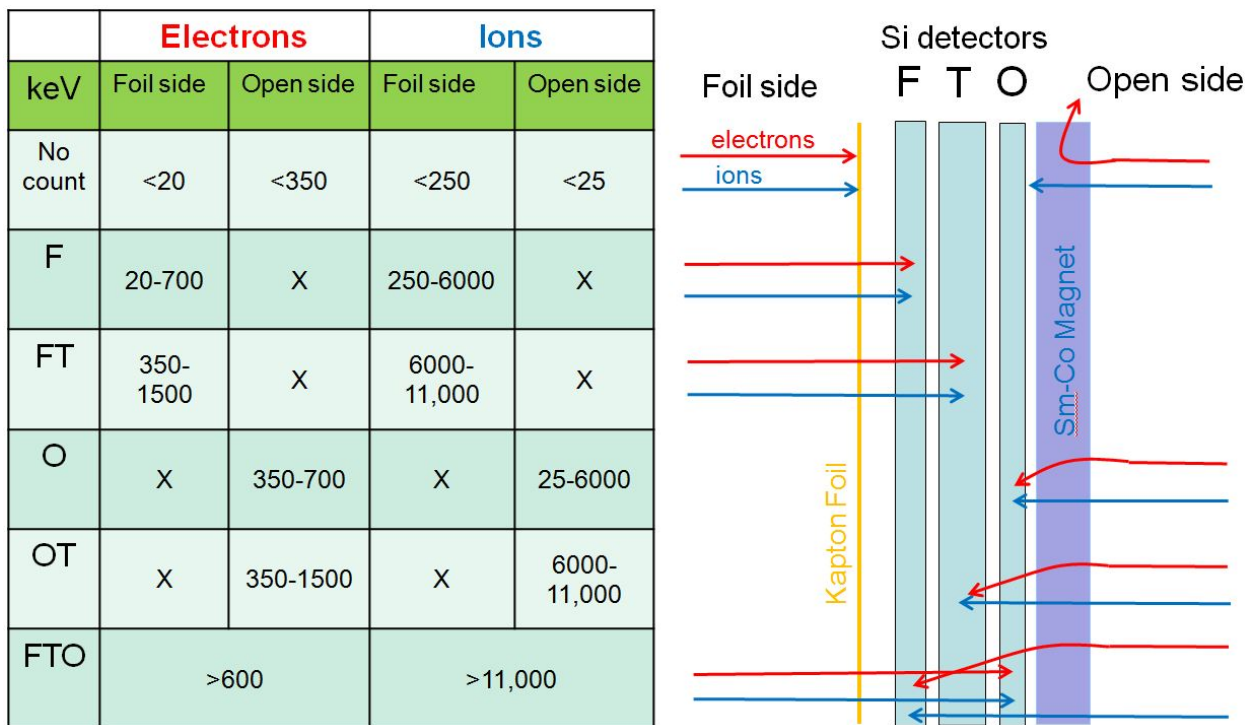

Figure 9: The table on the left shows the approximate ranges of energies of electrons or ions coming from the foil or open side that will result in the different types of events (F, FT, O, OT and FTO) recorded by the SEP sensor. The diagram on the right is aligned with each row of the table showing the paths of electrons (red) and ions (blue) from the foil or open side which results in these types of recorded events.



For each of the instrument maps (like the example shown in figure 5) and for each SEP sensor, a set of 192 response matrices were derived from GEANT4 simulations. Matrices were derived for both telescopes within each sensor (A and B), 6 event types (F, T, O, FT, OT, FTO), 4 particle types (electrons, protons, alphas and photons), 2 attenuator state (open and closed) and 2 particle directions (forward and reverse look directions). These matrices constitute a forward model for converting electron and ion energy spectra in 4 look directions into count rates in 256 counters in each SEP sensor. Figure 10 shows 2 of such response matrices for the “Flight2” instrument map shown in figure 5.

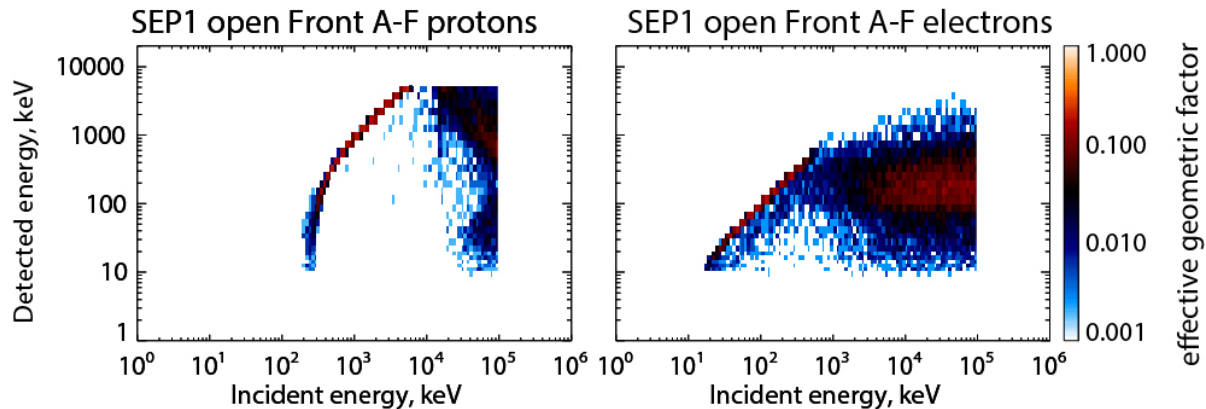

Figure 10: Two example response matrices derived from GEANT4 simulations. These show the effective geometric factor for protons (left) and electrons (right) coming from the front side of the SEP 1 sensor and causing ‘F’ energy deposition events in the ‘A’ telescope while the attenuator is open. The foil prevents protons with energies below  $\sim 250$  keV from causing counts, while electrons down to  $\sim 20$  keV cause counts.

Along with the gradient search algorithm, this forward model is used to fit for the electron and ion energy spectra (coming from the forward and reverse directions) that best fits the measured count rates in each of the 256 counters. These best-fit spectra constitute SEP calibrated level 2 data.

## 2.5 Measured Parameters

The primary science products are ion and electron spectra of differential energy flux, in 4 orthogonal look directions, convolved from onboard energy bins to regular, logarithmically-spaced energy bins from 20-2000 keV for electrons and 20- 13500 keV/nuc for ions.

## 2.6 Operational Modes

SEP has altitude-dependent sampling rates, but only one hardware mode. It is a ‘dumb’ instrument in the sense that it collects data continuously in the same manner.

## 2.7 Operational Considerations

During normal operation, SEP operates continuously in the same hardware mode, as described above in section 2.6. Since SEP has no high voltage, atmospheric pressure is not a consideration. However, when the sun is in one of the SEP FOVs, a spacecraft zone alert is triggered and the attenuator paddles automatically rotate to cover the field of view.

## 2.8 **In-Flight calibration [TBC]**

Cross- calibration of absolute flux can be performed with the SWIA instrument. SWIA measures 20 keV ions, albeit with a geometric factor  $\sim 330$  times smaller than SEP. Therefore, when the flux of such ions is sufficiently elevated (such as during the passage of a CME shock), measured fluxes from the same direction can be compared.

### 3 Data Overview

This section provides a high level description of archive organization under the PDS4 Information Model (IM) as well as the flow of the data from the spacecraft through delivery to PDS. Unless specified elsewhere in this document, the MAVEN SEP archive conforms with version 1.1.0.1 of the PDS4 IM [4] and version 1.0 of the MAVEN mission schema. A list of the XML Schema and Schematron documents associated with this archive are provided in Table 6 below.

*Table 6: MAVEN SEP Archive Schema and Schematron*

XML Document	Steward	Product LID
PDS Master Schema, v. 1.1.0.1	PDS	urn:nasa:pds:system_bundle:xml_schema:pds-xml_schema
PDS Master Schematron, v. 1.1.0.1	PDS	urn:nasa:pds:system_bundle:xml_schema:pds-xml_schema
MAVEN Mission Schema, v. 1.0	MAVEN	
MAVEN Mission Schematron, v. 1.0	MAVEN	

#### 3.1 Data Reduction Levels

A number of different systems may be used to describe data processing level. This document refers to data by their PDS4 reduction level. Table 7 provides a description of these levels along with the equivalent designations used in other systems.

*Table 7: Data reduction level designations*

PDS4 reduction level	PDS4 reduction level description	MAVEN Processing Level	CODMAC Level	NASA Level
Raw	Original data from an instrument. If compression, reformatting, packetization, or other translation has been applied to facilitate data transmission or storage, those processes are reversed so that the archived data are in a PDS approved archive format.	0	2	1A
Reduced	Data that have been processed beyond the raw stage but which are not yet entirely independent of the instrument.	1	2	1A
Calibrated	Data converted to physical units entirely independent of the instrument.	2	3	1B

<b>PDS4 reduction level</b>	<b>PDS4 reduction level description</b>	<b>MAVEN Processing Level</b>	<b>CODMAC Level</b>	<b>NASA Level</b>
Derived	Results that have been distilled from one or more calibrated data products (for example, maps, gravity or magnetic fields, or ring particle size distributions). Supplementary data, such as calibration tables or tables of viewing geometry, used to interpret observational data should also be classified as 'derived' data if not easily matched to one of the other three categories.	3+	4+	2+

### 3.2 Products

A PDS product consists of one or more digital and/or non-digital objects, and an accompanying PDS label file. Labeled digital objects are data products (i.e. electronically stored files). Labeled non-digital objects are physical and conceptual entities which have been described by a PDS label. PDS labels provide identification and description information for labeled objects. The PDS label defines a Logical Identifier (LID) by which any PDS labeled product is referenced throughout the system. In PDS4 labels are XML formatted ASCII files. More information on the formatting of PDS labels is provided in Section 6.3. More information on the usage of LIDs and the formation of MAVEN LIDs is provided in Section 5.1.

### 3.3 Product Organization

The highest level of organization for PDS archive is the bundle. A bundle is a list of one or more related collections of products, which may be of different types. A collection is a list of one or more related basic products, which are all of the same type. Figure 11 below illustrates these relationships.

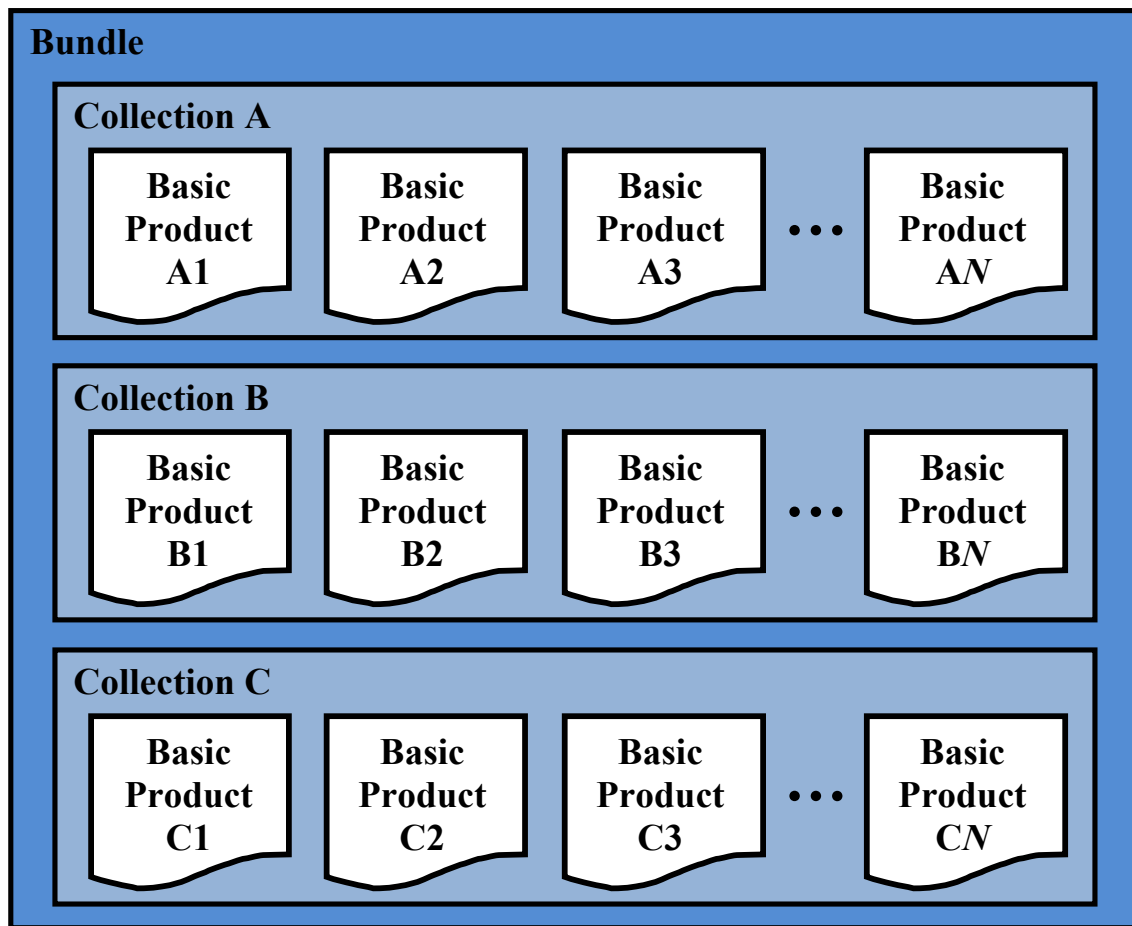

Figure 11: A graphical depiction of the relationship among bundles, collections, and basic products.

Bundles and collections are logical structures, not necessarily tied to any physical directory structure or organization. Bundle and collection membership is established by a member inventory list. Bundle member inventory lists are provided in the bundle product labels themselves. Collection member inventory lists are provided in separate collection inventory table files. Sample bundle and collection labels are provided in Appendix C and Appendix D, respectively.

### 3.3.1 Collection and Basic Product Types

Collections are limited to a single type of basic products. The types of archive collections that are defined in PDS4 are listed in Table 8.

Table 8: Collection product types

Collection Type	Description
Browse	Contains products intended for data characterization, search, and viewing, and not for scientific research or publication.

Context	Contains products which provide for the unique identification of objects which form the context for scientific observations (e.g. spacecraft, observatories, instruments, targets, etc.).
Document	Contains electronic document products which are part of the PDS Archive.
Data	Contains scientific data products intended for research and publication.
SPICE	Contains NAIF SPICE kernels.
XML_Schema	Contains XML schemas and related products which may be used for generating and validating PDS4 labels.

### 3.4 Bundle Products

The SEP data archive is organized into 3 bundles. A description of each bundle is provided in *Table 9*, and a more detailed description of the contents and format is provided in Section 5.2.

*Table 9: SEP Bundles*

Bundle Logical Identifier	PDS4 Reduction Level	Description	Data Provider
urn:nasa:pds:maven.sep.reduced	Reduced	Counts in each SEP sensor (1 or 2), telescope (A or B) and detector (F, T, O, OT, FT or FTO) at native time resolution	ITF
urn:nasa:pds:maven.sep.calibrated	Calibrated	Fully calibrated ion and electron energy flux spectra in 4 orthogonal look directions.	ITF
urn:nasa:pds:maven.sep.ancillary	Calibrated.	Ancillary data necessary for interpreting SEP Reduced and Calibrated data	ITF

### 3.5 Data Flow

This section describes only those portions of the MAVEN data flow that are directly connected to archiving. A full description of MAVEN data flow is provided in the MAVEN Science Data Management Plan [5]. A graphical representation of the full MAVEN data flow is provided in **Error! Reference source not found.**Figure 12 below.

Reduced (MAVEN level 1) data will be produced by RS and NGIMS as an intermediate processing product, and are delivered to the SDC for archiving at the PDS, but will not be used by the MAVEN team.

All ITFs will produce calibrated products. Following an initial 2-month period at the beginning of the mapping phase, the ITFs will routinely deliver preliminary calibrated data products to the SDC for use by the entire MAVEN team within two weeks of ITF receipt of all data needed to generate those products. The SOC will maintain an active archive of all MAVEN science data,

and will provide the MAVEN science team with direct access through the life of the MAVEN mission. After the end of the MAVEN project, PDS will be the sole long-term archive for all public MAVEN data.

Updates to calibrations, algorithms, and/or processing software are expected to occur regularly, resulting in appropriate production system updates followed by reprocessing of science data products by ITFs for delivery to SDC. Systems at the SOC, ITFs and PDS are designed to handle these periodic version changes.

Data bundles intended for the archive are identified in Table 8.

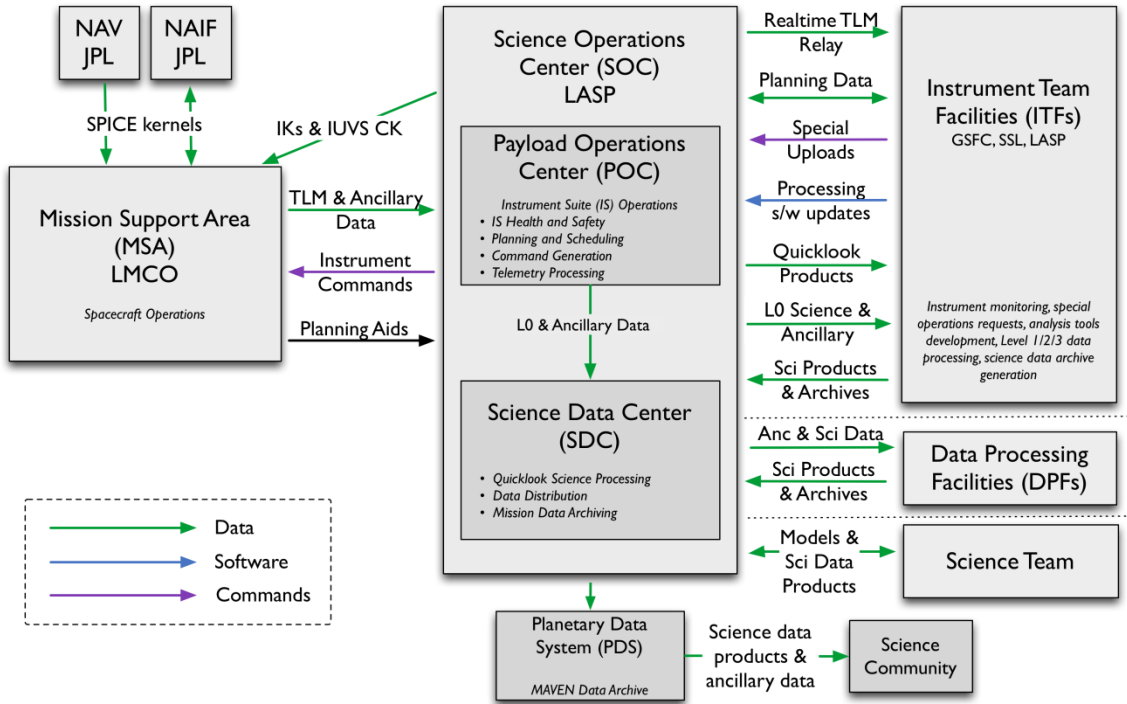

Figure 12: MAVEN Ground Data System responsibilities and data flow. Note that this figure includes portions of the MAVEN GDS which are not directly connected with archiving, and are therefore not described in Section 3.5 above.

## **4 Archive Generation**

The SEP archive products are produced by the SEP team in cooperation with the SDC, and with the support of the PDS Planetary Plasma Interactions (PPI) Node at the University of California, Los Angeles (UCLA). The archive volume creation process described in this section sets out the roles and responsibilities of each of these groups. The assignment of tasks has been agreed upon by all parties. Archived data received by the PPI Node from the SEP team are made available to PDS users electronically as soon as practicable but no later two weeks after the delivery and validation of the data.

### **4.1 Data Processing and Production Pipeline**

The following sections describe the process by which data products in each of the SEP bundles listed in Table 8 are produced.

#### **4.1.1 Reduced Data Production Pipeline**

Reduced SEP Level 1 data will be produced from the raw level 0 PF data files by the PF ITF using IDL software, and provided for archiving in the PDS in appropriate formats. The data production pipeline will be run in an automated fashion to produce archival-ready files from the raw level 0 data.

Beginning as soon as possible but no later than 2 months after the start of science operations, the PF ITF will routinely generate Level 1 SEP science data products and deliver them to the SOC. As there is no need for fitting or the application of dynamic calibration factors, the PF ITF will deliver preliminary SEP Level 1 products to the SDC for distribution to the MAVEN team within two weeks of receiving all data required for science processing and no later than needed to meet the PDS delivery schedule in Table 9.

#### **4.1.2 Calibrated Data Production Pipeline**

Calibrated SEP Level 2 data will be produced from the level 1 SEP data files by the PF ITF using IDL software, and provided for archiving in the PDS in appropriate formats. The data production pipeline will be run in an automated fashion to produce archival-ready files from the raw level 0 data.

Beginning as soon as possible but no later than 2 months after the start of science operations, the PF ITF will routinely generate Level 2 SEP science data products and deliver them to the SOC. After the initial 2-month calibration period, the PF ITF will deliver preliminary SEP Level 2 products to the SDC for distribution to the MAVEN team within two weeks of receiving all data required for science processing (including all SPICE kernels and other ancillary data required for processing) by the ITFs. Final Level 2 SEP products will be delivered to the SDC as soon as they are complete, no later than needed to meet the PDS delivery schedule in Table 9.

The PF ITF will deliver validated SEP science data products and associated metadata for PDS archiving to the SOC two weeks prior to every PDS delivery deadline. The first PDS delivery will occur no later than 6 months after the start of science operations, and subsequent deliveries will take place every 3 months after the first delivery. The first delivery will include data collected during the cruise and transition phases in addition to the science data from the first 3 months of the mapping phase. Each subsequent delivery will contain data from the 3 months



following the previous delivery. The final delivery may contain products involving data from the entire mission.

The PF ITF will also provide the SDC with SEP data product descriptions, appropriate for use by the MAVEN science team in using MAVEN science data products and consistent with PDS metadata standards.

### **4.1.3 Ancillary Data Production Pipeline**

SEP Ancillary data relies mainly on SPICE kernels. It will be delivered from the PF ITF to the SDC within two weeks of ITF receipt of validated kernel files.

## **4.2 Data Validation**

### **4.2.1 Instrument Team Validation**

All SEP data will be calibrated and converted to physical units by the PF ITF, then spot-checked by the instrument lead and his designees for accuracy and integrity.

### **4.2.2 MAVEN Science Team Validation**

The MAVEN science team will work with the same SEP products that will be archived in the PDS. If any calibration issues or other anomalies are noted, they will be addressed at the PF ITF by the SEP instrument lead or his designees.

### **4.2.3 PDS Peer Review**

The PPI node will conduct a full peer review of all of the data types that the SEP team intends to archive. The review data will consist of fully formed bundles populated with candidate final versions of the data and other products and the associated metadata.

*Table 10: MAVEN PDS review schedule*

Date	Activity	Responsible Team
2014-Mar-24	Signed SIS deadline	ITF
2014-Apr-18	Sample data products due	ITF
2014-May to 2014-Aug	Preliminary PDS peer review (SIS, sample data files)	PDS
2015-Mar-02	Release #1: Data due to PDS	ITF/SDC
2015-Mar to 2015-Apr	Release #1: Data PDS peer review	PDS
2015-May-01	Release #1: Public release	PDS

Reviews will include a preliminary delivery of sample products for validation and comment by

PDS PPI and Engineering node personnel. The data provider will then address the comments coming out of the preliminary review, and generate a full archive delivery to be used for the peer review.

Reviewers will include MAVEN Project and SEP team representatives, researchers from outside of the MAVEN project, and PDS personnel from the Engineering and PPI nodes. Reviewers will examine the sample data products to determine whether the data meet the stated science objectives of the instrument and the needs of the scientific community and to verify that the accompanying metadata are accurate and complete. The peer review committee will identify any liens on the data that must be resolved before the data can be ‘certified’ by PDS, a process by which data are made public as minor errors are corrected.

In addition to verifying the validity of the review data, this review will be used to verify that the data production pipeline by which the archive products are generated is robust. Additional deliveries made using this same pipeline will be validated at the PPI node, but will not require additional external review.

As expertise with the instrument and data develops the SEP team may decide that changes to the structure or content of its archive products are warranted. Any changes to the archive products or to the data production pipeline will require an additional round of review to verify that the revised products still meet the original scientific and archival requirements or whether those criteria have been appropriately modified. Whether subsequent reviews require external reviewers will be decided on a case-by-case basis and will depend upon the nature of the changes. A comprehensive record of modifications to the archive structure and content is kept in the Modification\_History element of the collection and bundle products.

The instrument team and other researchers are encouraged to archive additional SEP products that cover specific observations or data-taking activities. The schedule and structure of any additional archives are not covered by this document and should be worked out with the PPI node.

### **4.3 Data Transfer Methods and Delivery Schedule**

The SOC is responsible for delivering data products to the PDS for long-term archiving. While ITFs are primarily responsible for the design and generation of calibrated and derived data archives, the archival process is managed by the SOC. The SOC (in coordination with the ITFs) will also be primarily responsible for the design and generation of the raw data archive. The first PDS delivery will take place within 6 months of the start of science operations. Additional deliveries will occur every following 3 months and one final delivery will be made after the end of the mission. Science data are delivered to the PDS within 6 months of its collection. If it becomes necessary to reprocess data which have already been delivered to the archive, the ITFs will reprocess the data and deliver them to the SDC for inclusion in the next archive delivery. A summary of this schedule is provided in Table 11 below.

*Table 11: Archive bundle delivery schedule*

Bundle Logical Identifier	First Delivery to PDS	Delivery Schedule	Estimated Delivery Size
---------------------------	-----------------------	-------------------	-------------------------

urn:nasa:pds:maven.sep.reduced	No later than 6 months after the start of science operations	Every 3 months	TBD
urn:nasa:pds:maven.sep.calibrated	No later than 6 months after the start of science operations	Every 3 months	TBD
urn:nasa:pds:maven.sep.ancillary	No later than 6 months after the start of science operations	Every 3 months	TBD

Each delivery will comprise both data and ancillary data files organized into directory structures consistent with the archive design described in Section 5, and combined into a deliverable file(s) using file archive and compression software. When these files are unpacked at the PPI Node in the appropriate location, the constituent files will be organized into the archive structure.

Archive deliveries are made in the form of a “delivery package”. Delivery packages include all of the data being transferred along with a transfer manifest, which helps to identify all of the products included in the delivery, and a checksum manifest which helps to insure that integrity of the data is maintained through the delivery. The format of these files is described in Section 6.4.

Data are transferred electronically (using the *ssh* protocol) from the SOC to an agreed upon location within the PPI file system. PPI will provide the SOC a user account for this purpose. Each delivery package is made in the form of a compressed *tar* or *zip* archive. Only those files that have changed since the last delivery are included. The PPI operator will decompress the data, and verify that the archive is complete using the transfer and MD5 checksum manifests that were included in the delivery package. Archive delivery status will be tracked using a system defined by the PPI node.

Following receipt of a data delivery, PPI will reorganize the data into its PDS archive structure within its online data system. PPI will also update any of the required files associated with a PDS archive as necessitated by the data reorganization. Newly delivered data are made available publicly through the PPI online system once accompanying labels and other documentation have been validated. It is anticipated that this validation process will require no more than fourteen working days from receipt of the data by PPI. However, the first few data deliveries may require more time for the PPI Node to process before the data are made publicly available.

The MAVEN prime mission begins approximately 5 weeks following MOI and lasts for 1 Earth-year. Table 11 shows the data delivery schedule for the entire mission.

#### 4.4 Data Product and Archive Volume Size Estimates

SEP data products consist of files that span one UT day, breaking at 0h UTC SCET. Files vary in size depending on the telemetry rate and allocation.

#### 4.5 Data Validation

Routine data deliveries to the PDS are validated at the PPI node to insure that the delivery meets PDS standards, and that they conform to the standards defined in the SIS, and set in the peer review. As long as there are no changes to the data product formats, or data production pipeline no additional external review will be conducted.

#### 4.6 Backups and duplicates

The PPI Node keeps three copies of each archive product. One copy is the primary online archive copy, another is an onsite backup copy, and the final copy is an off-site backup copy. Once the archive products are fully validated and approved for inclusion in the archive, copies of the products are sent to the National Space Science Data Center (NSSDC) for long-term archive in a NASA-approved deep-storage facility. The PPI Node may maintain additional copies of the archive products, either on or off-site as deemed necessary. The process for the dissemination and preservation of SEP data is illustrated in **Error! Reference source not found.**

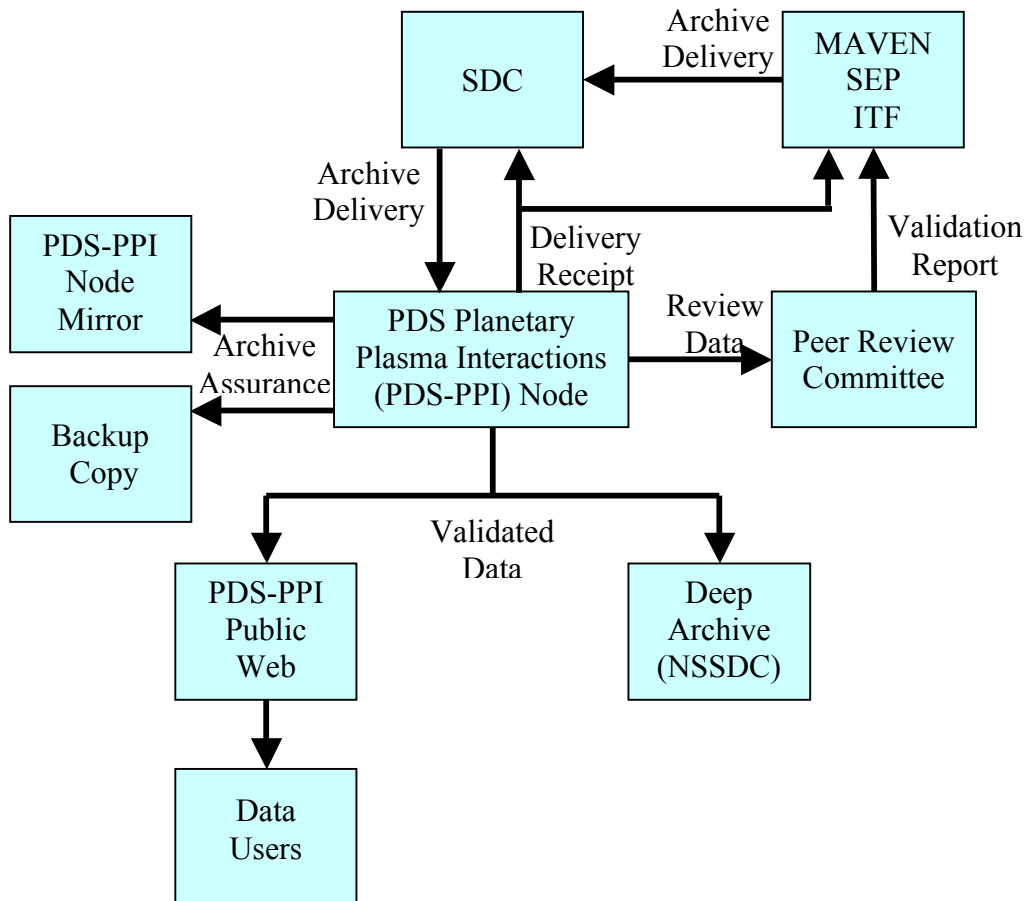

Figure 13: Duplication and dissemination of SEP archive products at PDS/PPI.

## 5 Archive organization and naming

This section describes the basic organization of a SEP bundle, and the naming conventions used for the product logical identifiers, and bundle, collection, and basic product filenames.

### 5.1 Logical Identifiers

Every product in PDS is assigned an identifier which allows it to be uniquely identified across the system. This identifier is referred to as a Logical Identifier or LID. A LIDVID (Versioned Logical Identifier) includes product version information, and allows different versions of a specific product to be referenced uniquely. A product's LID and VID are defined as separate attributes in the product label. LIDs and VIDs are assigned by the entity generating the labels and are formed according to the conventions described in sections 5.1.1 and 5.1.2 below. The uniqueness of a product's LIDVID may be verified using the PDS Registry and Harvest tools.

#### 5.1.1 LID Formation

LIDs take the form of a Uniform Resource Name (URN). LIDs are restricted to ASCII lower case letters, digits, dash, underscore, and period. Colons are also used, but only to separate prescribed components of the LID. Within one of these prescribed components dash, underscore, or period are used as separators. LIDs are limited in length to 255 characters.

MAVEN SEP LIDs are formed according to the following conventions:

- Bundle LIDs are formed by appending a bundle specific ID to the MAVEN SEP base ID:

urn:nasa:pds:maven.sep.<bundle ID>

Since all PDS bundle LIDs are constructed this way, the combination of maven.sep.bundle must be unique across all products archived with the PDS.

- Collection LIDs are formed by appending a collection specific ID to the collection's parent bundle LID:

urn:nasa:pds:maven.sep.<bundle ID>:<collection ID>

Since the collection LID is based on the bundle LID, which is unique across PDS, the only additional condition is that the collection ID must be unique across the bundle. Collection IDs correspond to the collection type (e.g. "browse", "data", "document", etc.). Additional descriptive information may be appended to the collection type (e.g. "data-raw", "data-calibrated", etc.) to insure that multiple collections of the same type within a single bundle have unique LIDs.

- Basic product LIDs are formed by appending a product specific ID to the product's parent collection LID:

urn:nasa:pds:maven.sep.<bundle ID>:<collection ID>:<product ID>

Since the product LID is based on the collection LID, which is unique across PDS, the only additional condition is that the product ID must be unique across the collection.

A list of SEP bundle LIDs is provided in *Table 9*. Collection LIDs are listed in **Error! Reference source not found.**

## 5.1.2 VID Formation

Product version ID's consist of major and minor components separated by a "." (M.n). Both components of the VID are integer values. The major component is initialized to a value of "1", and the minor component is initialized to a value of "0". The minor component resets to "0" when the major component is incremented.

## 5.2 SEP Archive Contents

The SEP archive includes the 3 bundles listed in *Table 9*. The following sections describe the contents of each of these bundles in greater detail.

### 5.2.1 SEP Reduced (MAVEN Level 1) Science Data Bundle

The sep.reduced Level 1 Science Data Bundle contains data in native instrument format, i.e. particle counts and supporting data.

*Table 12: sep.reduced Level 1 Science Data Collections*

Collection LID	Description
urn:nasa:pds:maven.sep.reduced:data.counts	Raw particle counts in each of the 256 event counters for each of the 2 SEP sensors.
urn:nasa:pds:maven.sep.reduced:document	Documents related to the sep.reduced bundle.

#### 5.2.1.1 sep.reduced:data.counts Data Collection

The SEP counts data collection contains files with time-ordered counts in each of the 256 event counters for each of the 2 SEP sensors, in addition to essential supporting data such as accumulation duration, attenuator state and energy map. The PF ITF will produce these products, with one file per UT day, with the naming convention mvn\_sep\_l1\_counts-\_*<yyyy><mm><dd>\_v<xx>\_r<yy>.cdf*

### 5.2.2 SEP Calibrated (MAVEN Level 2) Science Data Bundle

The sep.calibrated Level 2 Science Data Bundle contains fully calibrated data in physical units, including electron and ion spectra in the 4 look directions.

*Table 13: sep.calibrated Level 2 Science Data Collections*

Collection LID	Description
urn:nasa:pds:maven.sep.calibrated:data.spec	Electron and ion energy spectra in physical units in 4 look directions from SEP survey data.
urn:nasa:pds:maven.sep.calibrated:document	Documents related to the sep.calibrated bundle.

#### 5.2.2.1 sep.calibrated:data.spec Data Collection

The SEP spectra survey collection contains files with time-ordered fully calibrated ion and electron spectra in units of differential energy flux derived from the SEP survey and archive telemetry, as well as a header of ancillary information needed to interpret the data.

The PF ITF will produce these products, with one file per UT day, with the naming convention `mvn_sep_l2_cal-eflux-svy-_{yyyy}<mm><dd>_v<xx>_r<yy>.cdf`

### 5.2.3 SEP Ancillary (MAVEN Level 2) Science Data Bundle

The sep.ancillary Level 2 Science Data Bundle contains supporting ephemeris data useful in the interpretation of sep.calibrated data.

Table 14: sep.calibrated Level 2 Science Data Collections

Collection LID	Description
urn:nasa:pds:maven.sep.ancillary:data	Ephemeris data useful for interpretation of calibrated SEP data.
urn:nasa:pds:maven.sep.ancillary:document	Documents related to the sep.ancillary bundle.

#### 5.2.3.1 sep.ancillary:data Data Collection

The SEP ancillary collection contains files with time-ordered ephemeris information useful in the interpretation of sep.calibrated data

The PF ITF will produce these products, with one file per UT day, with the naming convention `mvn_sep_l2_anc_{yyyy}<mm><dd>_v<xx>_r<yy>.cdf`

### 5.3 Document Collection

The SEP calibrated data document collection contains documents which are useful for understanding and using the SEP Calibrated (MAVEN Level 2) Science Data bundle. Table 15 contains a list of the documents included in this collection, along with the LID, and responsible group. Following this a brief description of each document is also provided.

Table 15: SEP Reduced and Calibrated Science Data Documents

Document Name	LID	Responsibility
MAVEN Science Data Management Plan	urn:nasa:pds:maven:document:sdmp	MAVEN Project
MAVEN SEP Archive SIS	urn:nasa:pds:maven.sep:document:sis	SEP Team
MAVEN Mission Description	urn:nasa:pds:maven:document:mission.description	MAVEN Project
MAVEN Spacecraft Description	urn:nasa:pds:maven:document:spacecraft.description	MAVEN Project
SEP Instrument Description	urn:nasa:pds:maven.sep:document:sep.instrument.description	SEP Team
SEP Calibration Description	urn:nasa:pds:maven.sep.calibrated:document:calibration.description	SEP Team

**MAVEN Science Data Management Plan** – describes the data requirements for the MAVEN mission and the plan by which the MAVEN data system will meet those requirements

**MAVEN SEP Archive SIS** – describes the format and content of the SEP PDS data archive, including descriptions of the data products and associated metadata, and the archive format, content, and generation pipeline (this document)

**MAVEN Mission Description** – describes the MAVEN mission.

**MAVEN Spacecraft Description** – describes the MAVEN spacecraft.

**SEP Instrument Description** – describes the MAVEN SEP instrument.

**SEP Calibration Description** – describes the algorithms and procedures used to apply the calibration performed on the data included in this bundle

While responsibility for the individual documents varies, the document collection itself is managed by the PDS/PPI node.



## **6 Archive products formats**

Data that comprise the SEP archives are formatted in accordance with PDS specifications [see *Planetary Science Data Dictionary* [4], *PDS Data Provider's Handbook* [2], and *PDS Standards Reference* [3]. This section provides details on the formats used for each of the products included in the archive.

### **6.1 Data File Formats**

This section describes the format and record structure of each of the data file types. SEP reduced, calibrated and ancillary data files will be archived with PDS as Common Data Format (CDF). In order to allow the archival CDF files to be described by PDS metadata a number of requirements have been agreed to between the PF ITF and the PDS-PPI node. These requirements are detailed in the document Archive of MAVEN CDF in PDS4, Version 3, T. King and J. Mafi, March 13, 2014 [7]. These CDF files will be the same ones used and distributed by the PF ITF internally. The contents of the SEP CDF files are described in the tables below. **In all tables below, 'SEP-N' refers to either 'SEP-1' or 'SEP-2', in order to avoid unnecessary duplication.**

#### **6.1.1 Reduced data file structure**

For each SEP sensor, there is one CDF file per UT day containing Level 1 data, i.e. counts in each of the 256 particle counters for each SEP sensor, at the highest time resolution at which the data was downlinked.

Table 16: Contents for *sep.reduced:counts* data files. The first sub table contains relevant, non-time-varying information pertinent to the entire file. The 2nd sub table contains variables that vary with time. 'SEP-N' refers to either 'SEP-1' or 'SEP-2', in order to avoid unnecessary duplication.

Field Name	Data Type	Number elements	Description
DATA_MAP	INTEGER	256x8	Energy MAP (up to 8 maps are possible) Typically only 3 will be populated. The other 5 are reserved for future expansion. The integer is to be interpreted bitwise: Bits 0-11: bits 3:14 of the 16-bit pulse height analyzer values separating each of the 256 counters. Bit 12: Telescope ID of each counter. Telescope A is represented by 0 and telescope B is represented by 1. Bits 13-15: FTO pattern of each counter: 000: undefined. 001: O 010: T 011: OT 100: F 101: FO 110: FT 111: FTO
MAP_ENERGY_BOUNDS	FLOAT	256x2x8	Energies of the lower and upper bounds for each of the 256 counters in each map.
MAP_TID	BYTE	256x8	The telescope ID for each of the 256 counters. Telescope A is represented by 0 and telescope B is represented by 1 in each map.
MAP_FTO_PATTERN	INT	256x8	FTO pattern for each of the 256 counters in each map. E.g. 'F', 'FTO', 'OT' etc
Field Name	Data Type	Number elements	Description

EPOCH	EPOCH	NUM_SPEC	Spacecraft event time for this data record (UTC Epoch time from 01-Jan-0000 00:00:00.000 without leap seconds), one element per data sample
TIME_TT2000	TT2000	NUM_SPEC	UTC time from 01-Jan-2000 12:00:00.000 including leap seconds), one element per data sample
TIME_MET	DOUBLE	NUM_SPEC	Mission elapsed time for this data record, one element per data sample
TIME_UNIX	DOUBLE	NUM_SPEC	Unix time (elapsed seconds since 1970-01-01/00:00 without leap seconds) for this data record, one element per data sample
TIME_EPHEMERIS	DOUBLE	NUM_SPEC	Identical to UNIX time but with leap seconds added.
SEP-N_DURATION	INTEGER	NUM_SPEC	Number of one-second accumulations per sample.
SEP-N_ATTEN_STATE	INTEGER	NUM_SPEC	Attenuator state (0=invalid, 1 = open, 2 = closed, 3=mixed), one element per data sample
SEP-N_RAW_DATA	FLOAT	NUM_SPECx256	Raw counts in each of 256 SEP1 bins
SEP-N_MAPID	INT	NUM_SPEC	MAP number

### 6.1.2 Calibrated data file structure

For each SEP sensor, there is 1 CDF file per UT day containing level 2 data, i.e. calibrated electron and ion spectra in physical units (differential energy flux).

*Table 17: Contents for sep.calibrated.spec data files. The first sub table contains relevant, non-time-varying information pertinent to the entire file. The 2nd sub table contains variables that vary with time. 'SEP-N' refers to either 'SEP-1' or 'SEP-2', in order to avoid unnecessary duplication.*

Field Name	Data Type	Number elements	Description
ION_ENERGY	FLOAT	N_ION	Array of logarithmically-spaced ion energies (keV) covered by the spectrum, one array per file.
ELECTRON_ENERGY	FLOAT	N_ELEC	Array of logarithmically-spaced electron energies (keV) covered by the spectrum, one array per file.
Field Name	Data Type	Number elements	Description

Solar Energetic Particle Instrument (SEP) Data Product and Archive Volume SIS

EPOCH	EPOCH	NUM_SPEC	Spacecraft event time for this data record (UTC Epoch time from 01-Jan-0000 00:00:00.000 without leap seconds), one element per spectrum
TIME_TT2000	TT2000	NUM_SPEC	UTC time from 01-Jan-2000 12:00:00.000 including leap seconds), one element per spectrum
TIME_MET	DOUBLE	NUM_SPEC	Mission elapsed time for this data record, one element per spectrum
TIME_UNIX	DOUBLE	NUM_SPEC	Unix time (elapsed seconds since 1970-01-01/00:00 without leap seconds) for this data record, one element per spectrum
TIME_EPHEMERIS	DOUBLE	NUM_SPEC	Identical to UNIX time but with leap seconds added.
SEP-N_NUM_ACCUMULATION	INTEGER	NUM_SPEC	Number of one-second accumulations per spectrum.
SEP-N_ATTEN_STATE	INTEGER	NUM_SPEC	Attenuator state (0=invalid, 1 = open, 2 = closed, 3=invalidmixed), one element per spectrum
SEP-NF_ION_EFLUX	FLOAT	NUM_SPECxN_ION	N_ION-element array of ion differential energy fluxes [keV/(cm <sup>2</sup> s sr keV)] for the SEP-N Forward look direction.
SEP-NR_ION_EFLUX	FLOAT	NUM_SPECxN_ION	N_ION-element array of ion differential energy fluxes [keV/(cm <sup>2</sup> s sr keV)] for the SEP-N Reverse look direction.
SEP-NF_ELEC_EFLUX	FLOAT	NUM_SPECxN_ELEC	N_ELEC-element array of electron differential energy fluxes [keV/(cm <sup>2</sup> s sr keV)] for the SEP-N Forward look direction.
SEP-NR_ELEC_EFLUX	FLOAT	NUM_SPECxN_ELEC	N_ELEC-element array of electron differential energy fluxes [keV/(cm <sup>2</sup> s sr keV)] for the SEP-N Reverse look direction.

*Solar Energetic Particle Instrument (SEP) Data Product and Archive Volume SIS*

SEP- NF_ION_EFLUX_UN C	FLOAT	NUM_SPECxN_ION	N_ION-element array of uncertainty in ion differential energy fluxes [same units as eflux] for the SEP-N Forward look direction.
SEP- NR_ION_EFLUX_UN C	FLOAT	NUM_SPECxN_ION	N_ION-element array of uncertainty in ion differential energy fluxes [same units as eflux] for the SEP-N Forward look direction.
SEP- NF_ELEC_EFLUX_U NC	FLOAT	NUM_SPECxN_ION	N_ION-element array of uncertainty in electron differential energy fluxes [same units as eflux] for the SEP-N Forward look direction.
SEP- NR_ELEC_EFLUX_U NC	FLOAT	NUM_SPECxN_ION	N_ION-element array of uncertainty in electron differential energy fluxes [same units as eflux] for the SEP-N Forward look direction.

### 6.1.3 Ancillary data file structure

There is one CDF file per UT day containing ancillary ephemeris information relevant for the interpretation of the calibrated data from both SEP sensors.

Table 18: contents for *sep.ancillary:anc* data files.

Field Name	Data Type	Number elements	Description
EPOCH	EPOCH	NUM_SPEC	Spacecraft event time for this data record (UTC Epoch time from 01-Jan-0000 00:00:00.000 without leap seconds), one element per spectrum
TIME_TT2000	TT2000	NUM_SPEC	UTC time from 01-Jan-2000 12:00:00.000 including leap seconds), one element per spectrum
TIME_MET	DOUBLE	NUM_SPEC	Mission elapsed time for this data record, one element per spectrum
TIME_UNIX	DOUBLE	NUM_SPEC	Unix time (elapsed seconds since 1970-01-01/00:00 without leap seconds) for this data record, one element per spectrum
TIME_EPHEMERIS	DOUBLE	NUM_SPEC	Identical to UNIX time but with leap seconds added.
SEP-1F_FOV_MSO	DOUBLE	NUM_SPEC x 3	Unit vector of the geometric center of the 1-Forward field of view in Mars-solar-orbital coordinates
SEP-1R_FOV_MSO	DOUBLE	NUM_SPEC x 3	Unit vector of the geometric center of the 1-Reverse field of view in Mars-solar-orbital coordinates
SEP-2F_FOV_MSO	DOUBLE	NUM_SPEC x 3	Unit vector of the geometric center of the 2-Forward field of view in Mars-solar-orbital coordinates
SEP-2R_FOV_MSO	DOUBLE	NUM_SPEC x 3	Unit vector of the geometric center of the 2-Reverse field of view in Mars-solar-orbital coordinates
SEP-1F_FOV_SSO	DOUBLE	NUM_SPEC x 3	Unit vector of the geometric center of the 1-Forward field of view in Spacecraft-solar-orbital coordinates

Solar Energetic Particle Instrument (SEP) Data Product and Archive Volume SIS

SEP-1R_FOV_SSO	DOUBLE	NUM_SPEC x 3	Unit vector of the geometric center of the 1-Reverse field of view in Spacecraft-solar-orbital coordinates
SEP-2F_FOV_SSO	DOUBLE	NUM_SPEC x 3	Unit vector of the geometric center of the 2-Forward field of view in Spacecraft-solar-orbital coordinates
SEP-2R_FOV_SSO	DOUBLE	NUM_SPEC x 3	Unit vector of the geometric center of the 2-Reverse field of view in Spacecraft-solar-orbital coordinates
SEP-1F_FOV_GEO	DOUBLE	NUM_SPEC x 3	Unit vector of the geometric center of the 1-Forward field of view in planet-fixed IAU Mars coordinates
SEP-1R_FOV_GEO	DOUBLE	NUM_SPEC x 3	Unit vector of the geometric center of the 1-Reverse field of view in planet-fixed IAU Mars coordinates
SEP-2F_FOV_GEO	DOUBLE	NUM_SPEC x 3	Unit vector of the geometric center of the 2-Forward field of view in planet-fixed IAU Mars coordinates
SEP-2R_FOV_GEO	DOUBLE	NUM_SPEC x 3	Unit vector of the geometric center of the 2-Reverse field of view in planet-fixed IAU Mars coordinates
SEP-1F_SUN_ANGLE	DOUBLE	NUM_SPEC	Angle, in degrees, between the geometric center of the 1-Forward field of view and the direction of the sun.
SEP-1R_SUN_ANGLE	DOUBLE	NUM_SPEC	Angle, in degrees, between the geometric center of the 1-Reverse field of view and the direction of the sun.
SEP-2F_SUN_ANGLE	DOUBLE	NUM_SPEC	Angle, in degrees, between the geometric center of the 2-Forward field of view and the direction of the sun.
SEP-2R_SUN_ANGLE	DOUBLE	NUM_SPEC	Angle, in degrees, between the geometric center of the 2-Reverse field of view and the direction of the sun.
SEP-1F_RAM_ANGLE	DOUBLE	NUM_SPEC	Angle, in degrees, between the geometric center of the 1-Forward field of view and the spacecraft RAM direction.

SEP-1R_RAM_ANGLE	DOUBLE	NUM_SPEC	Angle, in degrees, between the geometric center of the 1-Reverse field of view and the spacecraft RAM direction.
SEP-2F_RAM_ANGLE	DOUBLE	NUM_SPEC	Angle, in degrees, between the geometric center of the 2-Forward field of view and the spacecraft RAM direction.
SEP-2R_RAM_ANGLE	DOUBLE	NUM_SPEC	Angle, in degrees, between the geometric center of the 2-Reverse field of view and the spacecraft RAM direction.
SEP-1F_FRAC_FOV_MARS	DOUBLE	NUM_SPEC	Fraction of the 1-Forward field of view taken up by the disk of Mars.
SEP-1R_FRAC_FOV_MARS	DOUBLE	NUM_SPEC	Fraction of the 1-Reverse field of view taken up by the disk of Mars.
SEP-2F_FRAC_FOV_MARS	DOUBLE	NUM_SPEC	Fraction of the 2-Forward field of view taken up by the disk of Mars.
SEP-2R_FRAC_FOV_MARS	DOUBLE	NUM_SPEC	Fraction of the 2-Reverse field of view taken up by the disk of Mars.
SEP-1F_FRAC_FOV_ILL	DOUBLE	NUM_SPEC	Fraction of the 1-Forward field of view taken up by the disk of Mars, weighted by the cosine of the illumination angle of each point on the disk.
SEP-1R_FRAC_FOV_ILL	DOUBLE	NUM_SPEC	Fraction of the 1-Reverse field of view taken up by the disk of Mars, weighted by the cosine of the illumination angle of each point on the disk.
SEP-2F_FRAC_FOV_ILL	DOUBLE	NUM_SPEC	Fraction of the 2-Forward field of view taken up by the disk of Mars, weighted by the cosine of the illumination angle of each point on the disk.
SEP-2R_FRAC_FOV_ILL	DOUBLE	NUM_SPEC	Fraction of the 2-Reverse field of view taken up by the disk of Mars, weighted by the cosine of the illumination angle of each point on the disk.
MARS_FRAC_SKY	DOUBLE	NUM_SPEC	Fraction of the complete celestial sphere taken up by Mars.



Solar Energetic Particle Instrument (SEP) Data Product and Archive Volume SIS

SEP-1_QROT2MSO	DOUBLE	NUM_SPEC x 4	Quaternions for the rotation between the SEP-1 and MSO reference frames.
SEP-2_QROT2MSO	DOUBLE	NUM_SPEC x 4	Quaternions for the rotation between the SEP-2 and MSO reference frames.
SEP-1_QROT2SSO	DOUBLE	NUM_SPEC x 4	Quaternions for the rotation between the SEP-1 and SSO reference frames.
SEP-2_QROT2SSO	DOUBLE	NUM_SPEC x 4	Quaternions for the rotation between the SEP-2 and SSO reference frames.
SEP-1_QROT2GEO	DOUBLE	NUM_SPEC x 4	Quaternions for the rotation between the SEP-1 and IAU Mars reference frames.
SEP-2_QROT2GEO	DOUBLE	NUM_SPEC x 4	Quaternions for the rotation between the SEP-2 and IAU Mars reference frames.
MVN_POS_MSO	DOUBLE	NUM_SPEC x 3	Position vector of the MAVEN spacecraft in Mars-solar-orbital coordinates, in units of km.
MVN_POS_GEO	DOUBLE	NUM_SPEC x 3	Position vector of the MAVEN spacecraft in IAU Mars coordinates, in units of km.
MVN_POS_ECLIPJ2000	DOUBLE	NUM_SPEC x 3	Position vector of the MAVEN spacecraft in sun-centered J2000 ecliptic coordinates, in units of km
EARTH_POS_ECLIPJ2000	DOUBLE	NUM_SPEC x 3	Position vector of Earth in sun-centered J2000 ecliptic coordinates, in units of km
MARS_POS_ECLIPJ2000	DOUBLE	NUM_SPEC x 3	Position vector of Mars in sun-centered J2000 ecliptic coordinates, in units of km
MVN_LAT_GEO	DOUBLE	NUM_SPEC	Latitude, in degrees, of sub-spacecraft point in planet-fixed IAU Mars coordinates
MVN_ELON_GEO	DOUBLE	NUM_SPEC	East Longitude, in degrees, of sub-spacecraft point in planet-fixed IAU Mars coordinates
MVN_SZA	DOUBLE	NUM_SPEC	Solar Zenith Angle, in degrees, of the MAVEN spacecraft with respect to Mars.
MVN_SLT	DOUBLE	NUM_SPEC	Solar Local Time, in hours, of the MAVEN spacecraft with respect to Mars.

## **6.2 Document Product File Formats**

Documents are provided in either Adobe Acrobat PDF/A or plain ASCII text format. Other versions of the document (including HTML, Microsoft Word, etc.) may be included as well.

## **6.3 PDS Labels**

PDS labels are ASCII text files written, in the eXtensible Markup Language (XML). All product labels are detached from the digital files (if any) containing the data objects they describe (except Product\_Bundle). There is one label for every product. Each product, however, may contain one or more data objects. The data objects of a given product may all reside in a single file, or they may be stored in multiple separate files. PDS4 label files must end with the file extension “.xml”.

The structure of PDS label files is governed by the XML documents described in Section 6.3.1.

### **6.3.1 XML Documents**

For the MAVEN mission PDS labels will conform to the PDS master schema based upon the 1.1.0.0 version of the PDS Information Model for structure, and the 1.1.0.0 version of the PDS Schematron for content. By use of an XML editor these documents may be used to validate the structure and content of the product labels.

Examples of PDS labels required for the SWIA archive are shown in Appendix C (bundle products), Appendix D (collection products), and Appendix E (basic products).

## **6.4 Delivery Package**

Data transfers, whether from data providers to PDS or from PDS to data users or to the deep archive, are accomplished using delivery packages. Delivery packages include the following required elements:

1. The package which consists of a compressed bundle of the products being transferred.
2. A transfer manifest which maps each product's LIDVID to the physical location of the product label in the package after uncompression.
3. A checksum manifest which lists the MD5 checksum of each file included in the package after uncompression.

SWIA archive delivery packages (including the transfer and checksum manifests) for delivery to PDS are produced at the MAVEN SDC.

### **6.4.1 The Package**

The directory structure used in for the delivery package is described in the Appendix in Section F.1. Delivery packages are compressed using either [zip, or tar/gzip] and are transferred electronically using the ssh protocol.

### **6.4.2 Transfer Manifest**

The “transfer manifest” is a file provided with each transfer to, from, or within PDS. The transfer manifest is external to the delivery package. It contains an entry for each label file in the

package, and maps the product LIDVID to the file specification name for the associated product's label file. Details of the structure of the transfer manifest are provided in Section F.2.

The transfer manifest is external to the delivery package, and is not an archive product. As a result, it does not require a PDS label.

### **6.4.3 Checksum Manifest**

The checksum manifest contains an MD5 checksum for every file included as part of the delivery package. This includes both the PDS product labels and the files containing the digital objects which they describe. The format used for a checksum manifest is the standard output generated by the md5deep utility. Details of the structure of the checksum manifest are provided in section F.3.

The checksum manifest is external to the delivery package, and is not an archive product. As a result, it does not require a PDS label.

## Appendix A Support staff and cognizant persons

Table 19: Archive support staff

SEP team			
Name	Address	Phone	Email
Davin Larson	Space Sciences Laboratory, 7 Gauss Way, University of California, Berkeley, CA 94720	+001-510-642-7558	davin@ssl.berkeley.edu
Robert Lillis	Space Sciences Laboratory, 7 Gauss Way, University of California, Berkeley, CA 94720	+001-510-642-6211	rlillis@ssl.berkeley.edu

UCLA			
Name	Address	Phone	Email
<b>Dr. Steven Joy</b> PPI Operations Manager	IGPP, University of California 405 Hilgard Avenue Los Angeles, CA 90095-1567 USA	+001 310 825 3506	sjoy@igpp.ucla.edu
<b>Mr. Joseph Mafi</b> PPI Data Engineer	IGPP, University of California 405 Hilgard Avenue Los Angeles, CA 90095-1567 USA	+001 310 206 6073	jmafi@igpp.ucla.edu

## Appendix B Naming conventions for MAVEN science data files

This section describes the naming convention used for science data files for the MAVEN mission.

### Raw (MAVEN Level 0):

mvn\_<inst>\_<grouping>\_l0\_<yyyy><mm><dd>\_v<xx>.dat

### Level 1, 2, 3+:

mvn\_<inst>\_<level>\_<descriptor>\_<yyyy><mm><dd>T<hh><mm><ss>\_v<xx>\_r<yy>.<ext>

Code	Description
<inst>	3-letter instrument ID
<grouping>	Three-letter code: options are all, svy, arc for all data, survey data, archive data. Primarily for P&F to divide their survey & archive data at Level 0.
<yyyy>	4-digit year
<mm>	2-digit month, e.g. 01, 12
<dd>	2-digit day of month, e.g. 02, 31
<hh>	2-digit hour, separated from the date by T. OPTIONAL. Will not be used
<mm>	2-digit minute. OPTIONAL. Will not be used by SEP
<ss>	2-digit second. OPTIONAL. Will not be used by SEP
r<yy>	2-digit data version: To be incremented each time a new version is submitted to the PDS. is this a new version of a previous file, though the same software version was used for both? (Likely to be used in the case of retransmits to fill in data gaps)
v<xx>	2-digit software version: which version of the software was used to create this data product?
<descriptor>	A description of the data. Defined by the creator of the dataset. There are no underscores in the value. SEP will adopt a standard: <descriptor>. = <GRP-PRC-TYPE-AVG> where: INST = sep, sep1, or sep2 GRP = svy PRC = cal or raw TYPE = spec or intg (spectra or integrated) AVG = full, 32sec, 5min Not all combinations will be available
.<ext>	File type extension: .fits, .txt, .cdf, .png
<level>	A code indicating the MAVEN processing level of the data (valid values: 11, 12, 13)

Instrument name	<instrument>
IUVS	Iuv

*Solar Energetic Particle Instrument (SEP) Data Product and Archive Volume SIS*

NGIMS	Ngi
LPW	Lpw
MAG	Mag
SEP	Sep
SWIA	Swi
SWEA	Swe
STATIC	Sta
P&F package	Pfp

## **Appendix C Sample Bundle Product Label**

This section provides a sample bundle product label.

## **Appendix D Sample Collection Product Label**

This section provides a sample collection product label.



## **Appendix E Sample Data Product Labels**

This section provides sample product labels for the various data types described in this document.

## **Appendix F PDS Delivery Package Manifest File Record Structures**

The delivery package includes two manifest files: a transfer manifest, and MD5 checksum manifest. When delivered as part of a data delivery, these two files are not PDS archive products, and do not require PDS labels files. The format of each of these files is described below.

### **F.1 Transfer Package Directory Structure**

[Insert a description of the directory structure contained in the delivery package.]

### **F.2 Transfer Manifest Record Structure**

The transfer manifest is defined as a two field fixed-width table where each row of the table describes one of the products in the package. The first field defines the LIDVID of each product in the package. The second field defines the file specification name of the corresponding product label in the package. The file specification name defines the name and location of the product relative to the location of the bundle product.

### **F.3 Checksum Manifest Record Structure**

The checksum manifest consists of two fields: a 32 character hexadecimal (using lowercase letters) MD5, and a file specification from the root directory of the unzipped delivery package to every file included in the package. The file specification uses forward slashes (“/”) as path delimiters. The two fields are separated by two spaces. Manifest records may be of variable length. This is the standard output format for a variety of MD5 checksum tools (*e.g.* md5deep, etc.).