

<b>Activity ID:</b> Orbit 10	<b>OAPEL TUCTORUS</b>		<b>SeqNo</b> 01
<b>Title</b>	UVS CALLISTO NEUTRAL TORUS, C10 INBOUND	<b>Instrument</b>	UVS
<b>Requestor</b>	UVS-MWG/S.STEPHENS	<b>Team</b> UVS	<b>Working Group</b> MWG
<b>Time System</b> CDS	<b>Load ID</b> C10A	<b>Calendar Date</b> 09/14/97	<b>Week</b> 37
<b>Start</b>	JEE-CDS 00006594:00:0	97-257/08:02:59.933	JEE-004/15:07:16.000
<b>End</b>	JEE-CDS 00004070:00:0	97-259/02:35:02.600	JEE-002/20:35:13.333
<b>Duration</b>	00002524:00:0	001/18:32:02.667	001/18:32:02.667
<b>Top Label</b>	10TUCTORUS01-		
<b>Bottom Label</b>	UVS RTS Callisto Neutral Torus		
<b>Plot Key</b>	UVS	<b>Type</b>	SCI
<b>CDS Bytes</b>	799	<b>Report Options</b>	BOTH
<b>CDS Source</b>	OAP	<b>Spin State</b>	DUAL
		<b>Scan Platform</b>	Yes
		<b>DMS</b>	No
<b>Observation Objective</b>			
<p>UVS CALLISTO NEUTRAL TORUS MIDNIGHT ANSA PROFILE 1, C10 INBOUND                  (GLL-Jup = 41.6 Rj):                  TARGET 1: From 27.96 Rj (ansa at 26.26 Rj) to 24.53 Rj, cone 90                  (GLL-Jup = 46.66 Rj)                  TARGET 2: From 27.85 Rj (ansa at 26.09 Rj) to 24.23 Rj, cone &gt; 90                  (GLL-Jup = 43.52 Rj)                  TARGET 3: From 28.00 Rj (ansa at 26.10 Rj) to 24.08 Rj, cone &gt; 90                  (GLL-Jup = 40.24 Rj)                  TARGET 4: From 28.64 Rj (ansa at 26.14 Rj) to 23.49 Rj, cone &gt; 90                  (GLL-Jup = 36.47 Rj)                  UVFLUSH STRATEGY (17,712 bits per UVS PACKET; data rate 2.43 bps                  UVS):                  UVS deselected; 120-RIM UVFLUSHes needed to PACKET UVS after                  initial DISCRD                  Total bits: 21 UVS UVFLUSH PACKETS = 0.372 MB UVS                  WAVELENGTHS (Angstroms):                  Emission lines: UVS (H 1215, neutral O 1304)</p>			
<b>Design Detail</b>			
PSID	RIM:mf	CDS PA	
384BI	0	0	COMMENT [UVS RIM 0]
61BC	1	37	LOOPER [LOOP PERIOD 60, NUM LOOPS 42]
157BG	3	38	CMDRS (10+14*2) [PLAN DUR 31, EST UVS CMDS 2]
349MT	3:69	28	UVFLUSH [6UVRT, DISCRD, UVS]
165BF	4	27	TARGET [CONE 90.00, CLOCK 95.34, POSITION SLEW ALLOCATION 4]
	4		34UVS,D1,F,N,N,N,S,0,OFF,OFF,ON,ON,OFF,NO,1,5A,45,00,39 [16STEP G/G]
	34		34UVS,C1,F,N,N,N,S,0,OFF,OFF,ON,OFF,OFF,NO,1,2C,05,00,00 [HVOPF]
349MU	122:69	588	UVFLUSH (28*21) [6UVRT, PACKET, UVS]
...NO			... [REPEAT 20 ADDITIONAL TIMES]
165BP	604	27	TARGET [CONE 95.28, CLOCK 95.47, POSITION SLEW ALLOCATION 1]
165BQ	1204	27	TARGET [CONE 102.01, CLOCK 95.65, POSITION SLEW ALLOCATION 1]
165BR	1804	27	TARGET [CONE 111.47, CLOCK 95.97, POSITION SLEW ALLOCATION 1]

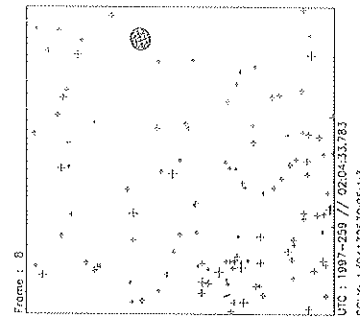
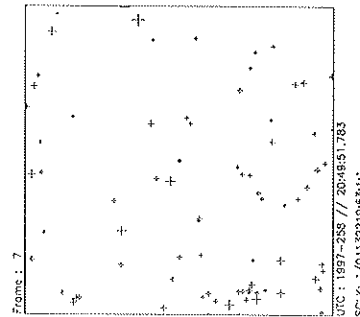
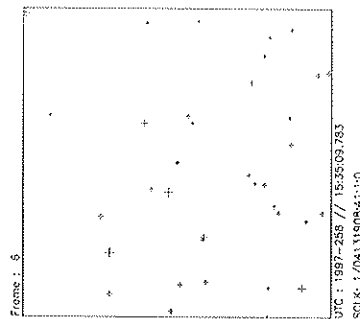
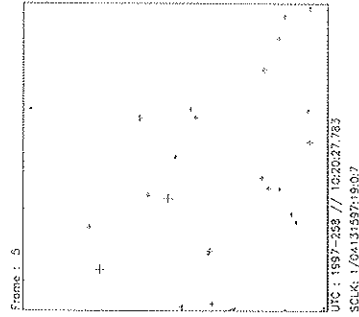
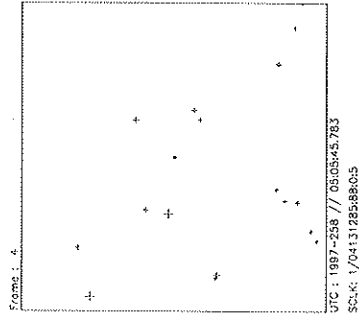
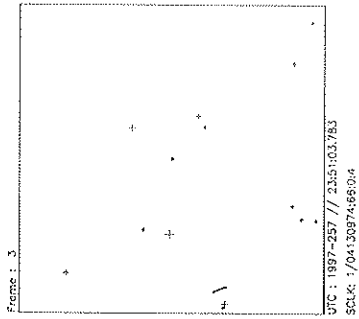
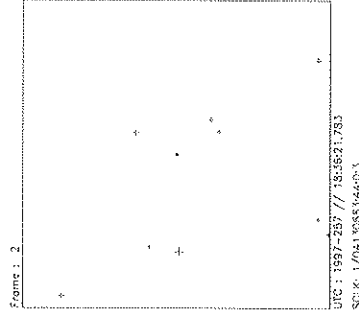
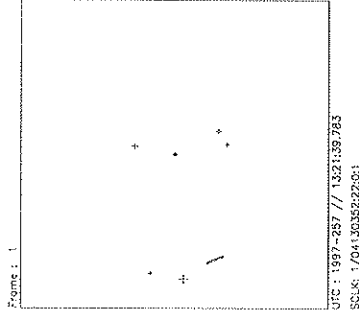
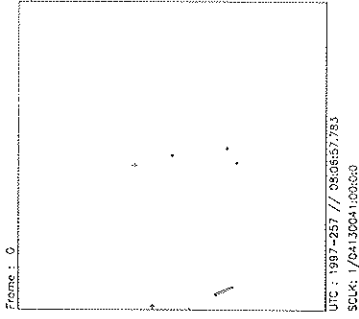

Start UTC\_TIME : 1997-257 // 08:06:57.783  
End UTC\_TIME : 1997-259 // 07:07:57.862  
Start SCLK : 1/04130041:00:00  
Delta Time between FOW : 18882.00  
FOWs : F Channel(0.1x0.4), N/G Channel(0.1x1.0)

Target Body : CALLISTO  
Target Cone/Clock : 82.43 / 95.20 Deg  
S/C to Body Center : 2100899. Km ( 874.28188 Rc )  
Z-axis Pointing ( Rc / Dec ) : 137.29 / 18.97 Deg

<b>Activity ID:</b> Orbit 10	<b>OAPEL HUMAGNEB</b>	<b>SeqNo</b> 01-
<b>Title</b>	UVS MAGNETONEBULA OBSERVATION 1	<b>Instrument</b> UVS
<b>Requestor</b>	UVS-MWG/S.STEPHENS	<b>Team</b> UVS
		<b>Working Group</b> MWG
<b>Time System</b> CDS	<b>Load ID</b> C10B	<b>Calendar Date</b> 09/22/97
		<b>Week</b> 38
<b>Start</b>	JEE+CDS 00004480:00:0	97-265/02:40:02.599
		JEE+003/03:29:46.666
<b>End</b>	JEE+CDS 00005909:00:0	97-266/02:44:55.266
		JEE+004/03:34:39.333
<b>Duration</b>	00001429:00:0	001/00:04:52.667
		001/00:04:52.667
<b>Top Label</b>	10HUMAGNEB01-	
<b>Bottom Label</b>	UVS RTS Magnetonebula	
<b>Plot Key</b>	UVS	<b>Type</b> SCI
<b>CDS Bytes</b>	161	<b>Report Options</b> BOTH
		<b>Scan Platform</b> Yes
<b>CDS Source</b>	OAP	<b>Spin State</b> DUAL
		<b>DMS</b> No
<b>Observation Objective</b>		
	UVS MAGNETONEBULA OBSERVATION 1, C10 CRUISE (GLL-Jup = 40.2 Rj):	
	From: nearly anti-solar direction, cone 175.00	
	To: constant cone angle, rotating clock angle (due to Scan-Type 3)	
	UVFLUSH STRATEGY (17,712 bits per UVS PACKET; data rate 0.21 bps UVS):	
	UVS deselected, 1424-RIM UVFLUSH needed to PACKET UVS after initial DISCRD	
	Total bits: 1 UVS UVFLUSH PACKET = 0.018 MB UVS	
	WAVELENGTHS (Angstroms):	
	Emission lines: UVS (neutral O 1304)	
	2POSN-1STEP G/G MINISCAN (UVS): G 1304.3 (STEP 112) [EVEN FRAMES],	
	G 1319.6 (STEP 122) [ODD FRAMES]	
Strategy for MINISCANS: Use 1STEP MINISCAN for PWS quiet		
<b>Design Detail</b>		
PSID	RIM:mf	CDS PA
384BJ	-3	0 COMMENT [UVS RIM 0]
176BA	-3	15 SCITLM [PAUSE PB]
157BH	4	24 CMDRS (10+14*1) [PLAN DUR 1, EST UVS CMDS 1]
165BG	4	27 TARGET [CONE 175.00, CLOCK 90.00, POSITION SLEW ALLOCATION 4], S/T 3
349NP	4:69	28 UVFLUSH [6UVRT, DISCRD, UVS]
	5	34UVS,C1,F,N,N,N,S,0,OFF,OFF,ON,ON,OFF,NO,1,9C,05,00,0A [1STEP G/G]
176BB	6	15 SCITLM [RESUME PB]
349NQ	1427:69	28 UVFLUSH [6UVRT, PACKET, UVS]
157BI	1428	24 CMDRS (10+14*1) [PLAN DUR 1, EST UVS CMDS 1]
	1429	34UVS,C1,F,N,N,N,S,0,OFF,OFF,ON,OFF,OFF,NO,1,2C,05,00,00 [HVOFF]

Activity ID:	Orbit 10	OAPEL HUMAGNEB	SeqNo	03-
Title	UVS MAGNETONEBULA OBSERVATION 3		Instrument	UVS
Requestor	UVS-MWG/S.STEPHENS	Team	UVS	Working Group
				MWG

Time System	CDS	Load ID	C10B	Calendar Date	09/27/97	Week	39
Start	JEE+CDS 00012860:00:0			97-270/23:53:09.266			JEE+009/00:42:53.333
End	JEE+CDS 00013045:00:0			97-271/03:00:12.599			JEE+009/03:49:56.666
Duration	00000185:00:0			000/03:07:03.333			000/03:07:03.333

Top Label	10HUMAGNEB03-			
Bottom Label	UVS RTS Magnetonebula			
Plot Key	UVS	Type	SCI	
CDS Bytes	151	Report Options	BOTH	Scan Platform
				Yes
CDS Source	OAP	Spin State	DUAL	DMS
				No

**Observation Objective**

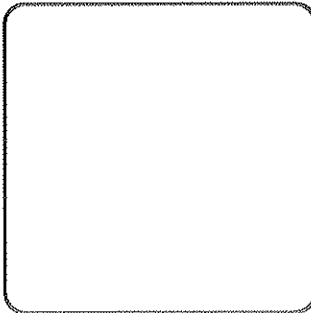

UVS MAGNETONEBULA OBSERVATION 3, C10 CRUISE (GLL-Jup = 70.3 Rj):  
 From: nearly anti-solar direction, cone 175.00  
 To: constant cone angle, rotating clock angle (due to Scan-Type 3)  
 UVFLUSH STRATEGY (17,712 bits per UVS PACKET; data rate 1.62 bps UVS):  
 UVS deselected, 180-RIM UVFLUSH needed to PACKET UVS after initial DISCRD  
 Total bits: 1 UVS UVFLUSH PACKET = 0.018 MB UVS  
 WAVELENGTHS (Angstroms):  
 Emission lines: UVS (H Lyman-alpha 1215)  
 FULLSCAN G (UVS): G 1131.5-1920.1 (CTR 1534.7, STEP 264) [BOTH FRAMES]  
 Strategy for MINISCANS: Use FULLSCAN G to move grating and to monitor "ghost" anomaly

**Design Detail**

PSID	RIM:mf	CDS PA	
384BL	-3	0	COMMENT [UVS RIM 0]
176BE	-3	15	SCITLM [PAUSE PB]
157BL	4	38	CMDRS (10+14*2) [PLAN DUR 181, EST UVS CMDS 2]
165BI	4	27	TARGET [CONE 175.00, CLOCK 90.00, POSITION SLEW ALLOCATION 4], S/T 3
349NT	4:69	28	UVFLUSH [6UVRT, DISCRD, UVS]
		5	34UVS, 07, S, N, N, N, S, 0, OFF, OFF, ON, ON, OFF, NO, 1, 2C, 9D, 00, 00 [FULLSCAN G]
176BF	6	15	SCITLM [RESUME PB]
349NU	183:69	28	UVFLUSH [6UVRT, PACKET, UVS]
		185	34UVS, C1, F, N, N, N, S, 0, OFF, OFF, ON, OFF, OFF, NO, 1, 2C, 05, 00, 00 [HVOFF]

<b>Activity ID:</b> Orbit 10	<b>OAPEL</b> HUMAGNEB	<b>SeqNo</b> 04-
<b>Title</b>	UVS MAGNETONEBULA OBSERVATION 4	<b>Instrument</b> UVS
<b>Requestor</b>	UVS-MWG/S.STEPHENS	<b>Team</b> UVS
		<b>Working Group</b> MWG
<b>Time System</b> CDS	<b>Load ID</b> C10B	<b>Calendar Date</b> 10/03/97
		<b>Week</b> 40
<b>Start</b>	JEE+CDS 00021226:00:0	97-276/20:52:06.599
		JEE+014/21:41:50.666
<b>End</b>	JEE+CDS 00021411:00:0	97-276/23:59:09.933
		JEE+015/00:48:54.000
<b>Duration</b>	00000185:00:0	000/03:07:03.334
		000/03:07:03.334
<b>Top Label</b>	10HUMAGNEB04-	
<b>Bottom Label</b>	UVS RTS Magnetonebula	
<b>Plot Key</b>	UVS	<b>Type</b> SCI
<b>CDS Bytes</b>	94	<b>Report Options</b> BOTH
		<b>Scan Platform</b> Yes
<b>CDS Source</b>	OAP	<b>Spin State</b> DUAL
		<b>DMS</b> No
<b>Observation Objective</b>		
	UVS MAGNETONEBULA OBSERVATION 4, C10 CRUISE (GLL-Jup = 88.6 Rj):	
	From: nearly anti-solar direction, cone 175.00	
	To: constant cone angle, rotating clock angle (due to Scan-Type	
	3)	
	UVFLUSH STRATEGY (17,712 bits per UVS PACKET; data rate 1.62 bps	
	UVS):	
	UVS deselected, 180-RIM UVFLUSH needed to PACKET UVS after initial	
	DISCRD	
	Total bits: 1 UVS UVFLUSH PACKET = 0.018 MB UVS	
	WAVELENGTHS (Angstroms):	
Emission lines: UVS (H Lyman-alpha 1215)		
2 POSN-88STEP G/G MINISCAN (UVS): G 1131.5-1265.9 (CTR 1199.7, STEP		
44) [EVEN FRAMES],		
G 1199.7-1333.4 (CTR 1267.5, STEP		
88) [ODD FRAMES]		
Strategy for MINISCANS: Use 88STEP G/G to move grating and to		
monitor "ghost" anomaly		
<b>Design Detail</b>		
PSID	RIM:mf	CDS PA
384BM	-3	0 COMMENT [UVS RIM 0]
157BM	4	38 CMDRS (10+14*2) [PLAN DUR 181, EST UVS CMDS 2]
349NV	4:69	28 UVFLUSH [6UVRT, DISCRD, UVS]
	5	34UVS,DF,F,N,N,N,S,0,OFF,OFF,ON,ON,OFF,NO,1,2C,7D,00,2C [88STEP G/G]
349NW	183:69	28 UVFLUSH [6UVRT, PACKET, UVS]
	185	34UVS,C1,F,N,N,N,S,0,OFF,OFF,ON,OFF,OFF,NO,1,2C,05,00,00 [HVOFF]

<b>Activity ID:</b> Orbit 10	<b>OAPEL</b> HUMAGNEB	<b>SeqNo</b> 05-
<b>Title</b>	UVS MAGNETONEBULA OBSERVATION 5	<b>Instrument</b> UVS
<b>Requestor</b>	UVS-MWG/S.STEPHENS	<b>Team</b> UVS
		<b>Working Group</b> MWG
<b>Time System</b> CDS	<b>Load ID</b> C10B	<b>Calendar Date</b> 10/11/97
		<b>Week</b> 41
<b>Start</b>	JEE+CDS 00032796:00:0	97-284/23:50:39.933
		JEE+023/00:40:24.000
<b>End</b>	JEE+CDS 00032981:00:0	97-285/02:57:43.266
		JEE+023/03:47:27.333
<b>Duration</b>	00000185:00:0	000/03:07:03.333
		000/03:07:03.333
<b>Top Label</b>	10HUMAGNEB05-	
<b>Bottom Label</b>	UVS RTS Magnetonebula	
<b>Plot Key</b>	UVS	<b>Type</b> SCI
<b>CDS Bytes</b>	151	<b>Report Options</b> BOTH
		<b>Scan Platform</b> Yes
<b>CDS Source</b>	OAP	<b>Spin State</b> DUAL
		<b>DMS</b> No
<b>Observation Objective</b>		
	UVS MAGNETONEBULA OBSERVATION 5, C10 CRUISE (GLL-Jup = 98.8 Rj):	
	From: nearly anti-solar direction, cone 175.00	
	To: constant cone angle, rotating clock angle (due to Scan-Type 3)	
	UVFLUSH STRATEGY (17,712 bits per UVS PACKET; data rate 1.62 bps UVS):	
	UVS deselected, 180-RIM UVFLUSH needed to PACKET UVS after initial DISCRD	
	Total bits: 1 UVS UVFLUSH PACKET = 0.018 MB UVS	
	WAVELENGTHS (Angstroms):	
	Emission lines: UVS (H Lyman-alpha 1215)	
	FULLSCAN G (UVS): G 1131.5-1920.1 (CTR 1534.7, STEP 264) [BOTH FRAMES]	
	Strategy for MINISCANS: Use FULLSCAN G to move grating and to monitor "ghost" anomaly	
<b>Design Detail</b>		
PSID	RIM:mf	CDS PA
384BN	-3	0 COMMENT [UVS RIM 0]
176BI	-3	15 SCITLM [PAUSE PB]
157BN	4	38 CMDRS (10+14*2) [PLAN DUR 181, EST UVS CMDS 2]
165BK	4	27 TARGET [CONE 175.00, CLOCK 90.00, POSITION SLEW ALLOCATION 4], S/T 3
349NX	4:69	28 UVFLUSH [6UVRT, DISCRD, UVS]
	5	34UVS,07,S,N,N,N,S,0,OFF,OFF,ON,ON,OFF,NO,1,2C,9D,00,00 [FULLSCAN G]
176BJ	6	15 SCITLM [RESUME PB]
349NY	183:69	28 UVFLUSH [6UVRT, PACKET, UVS]
	185	34UVS,C1,F,N,N,N,S,0,OFF,OFF,ON,OFF,OFF,NO,1,2C,05,00,00 [HVOFF]

Activity ID: Orbit 10		OAPEL HUMAGNEB		SeqNo 06-	
Title	UVS MAGNETONEBULA OBSERVATION 6			Instrument	UVS
Requestor	UVS-MWG/S.STEPHENS	Team	UVS	Working Group	MWG
Time System	CDS	Load ID	C10B	Calendar Date	10/20/97
				Week	42
Start	JEE+CDS 00045610:00:0		97-293/23:47:02.599		JEE+032/00:36:46.666
End	JEE+CDS 00045795:00:0		97-294/02:54:05.933		JEE+032/03:43:50.000
Duration	00000185:00:0		000/03:07:03.334		000/03:07:03.334
Top Label	10HUMAGNEB06-				
Bottom Label	UVS RTS Magnetonebula				
Plot Key	UVS	Type	SCI		
CDS Bytes	151	Report Options	BOTH	Scan Platform	Yes
CDS Source	OAP	Spin State	DUAL	DMS	No
<b>Observation Objective</b>					
<div style="border: 1px solid black; width: 150px; height: 100px; display: inline-block; vertical-align: top;"></div> <p>UVS MAGNETONEBULA OBSERVATION 6, C10 CRUISE (GLL-Jup = 92.5 Rj):                  From: nearly anti-solar direction, cone 175.00                  To: constant cone angle, rotating clock angle (due to Scan-Type 3)                  UVFLUSH STRATEGY (17,712 bits per UVS PACKET; data rate 1.62 bps UVS):                  UVS deselected, 180-RIM UVFLUSH needed to PACKET UVS after initial DISCRD                  Total bits: 1 UVS UVFLUSH PACKET = 0.018 MB UVS                  WAVELENGTHS (Angstroms):                  Emission lines: UVS (H Lyman-alpha 1215)                  2 POSN-88STEP G/G MINISCAN (UVS): G 1131.5-1265.9 (CTR 1199.7, STEP 44) [EVEN FRAMES],                  G 1199.7-1333.4 (CTR 1267.5, STEP 88) [ODD FRAMES]                  Strategy for MINISCANS: Use 88STEP G/G to move grating and to monitor 'ghost' anomaly</p>					
<b>Design Detail</b>					
PSID	RIM:mf	CDS	PA		
384BO	-3	0	COMMENT [UVS RIM 0]		
176BK	-3	15	SCITLM [PAUSE PB]		
157BO	4	38	CMDRS (10+14*2) [PLAN DUR 181, EST UVS CMDS 2]		
165BL	4	27	TARGET [CONE 175.00, CLOCK 90.00, POSITION SLEW ALLOCATION 4], S/T 3		
349NZ	4:69	28	UVFLUSH [6UVRT, DISCRD, UVS]		
		5	34UVS,DF,F,N,N,N,S,0,OFF,OFF,ON,ON,OFF,NO,1,2C,7D,00,2C [88STEP G/G]		
176BL	6	15	SCITLM [RESUME PB]		
349OA	183:69	28	UVFLUSH [6UVRT, PACKET, UVS]		
	185		34UVS,C1,F,N,N,N,S,0,OFF,OFF,ON,OFF,OFF,NO,1,2C,05,00,00 [HVOFF]		

<b>Activity ID:</b> Orbit 10		OAPEL HUMAGNEB		<b>SeqNo</b> 07-	
<b>Title</b>	UVS MAGNETONEBULA OBSERVATION 7			<b>Instrument</b>	UVS
<b>Requestor</b>	UVS-MWG/S.STEPHENS	<b>Team</b>	UVS	<b>Working Group</b>	MWG
<b>Time System</b>	CDS	<b>Load ID</b>	C10B	<b>Calendar Date</b>	10/26/97
				<b>Week</b>	43
<b>Start</b>	JEE+CDS 00053976:00:0		97-299/20:45:59.933		JEE+037/21:35:44.000
<b>End</b>	JEE+CDS 00054161:00:0		97-299/23:53:03.266		JEE+038/00:42:47.333
<b>Duration</b>	00000185:00:0		000/03:07:03.333		000/03:07:03.333
<b>Top Label</b>	10HUMAGNEB07-				
<b>Bottom Label</b>	UVS RTS Magnetonebula				
<b>Plot Key</b>	UVS	<b>Type</b>	SCI		
<b>CDS Bytes</b>	94	<b>Report Options</b>	BOTH	<b>Scan Platform</b>	Yes
<b>CDS Source</b>	OAP	<b>Spin State</b>	DUAL	<b>DMS</b>	No
<b>Observation Objective</b>					
	UVS MAGNETONEBULA OBSERVATION 7, C10 CRUISE (GLL-Jup = 77.7 Rj):				
	From: nearly anti-solar direction, cone 175.00				
	To: constant cone angle, rotating clock angle (due to Scan-Type 3)				
	UVFLUSH STRATEGY (17,712 bits per UVS PACKET; data rate 1.62 bps UVS):				
	UVS deselected, 180-RIM UVFLUSH needed to PACKET UVS after initial DISCRD				
	Total bits: 1 UVS UVFLUSH PACKET = 0.018 MB UVS				
	WAVELENGTHS (Angstroms):				
	Emission lines: UVS (H Lyman-alpha 1215)				
	FULLSCAN G (UVS): G 1131.5-1920.1 (CTR 1534.7, STEP 264) [BOTH FRAMES]				
	Strategy for MINISCANS: Use FULLSCAN G to move grating and to monitor "ghost" anomaly				
NOTE: Redundant TARGET removed from observation at 3rd OP input port (along with SCITLMs)					
<b>Design Detail</b>					
PSID	RIM:mf	CDS	PA		
384BP	-3	0	COMMENT [UVS RIM 0]		
157BP	4	38	CMDRS (10+14*2) [PLAN DUR 181, EST UVS CMDS 2]		
3490B	4:69	28	UVFLUSH [6UVRT, DISCRD, UVS]		
	5		34UVS,07,S,N,N,N,S,0,OFF,OFF,ON,ON,OFF,NO,1,2C,9D,00,00 [FULLSCAN G]		
3490C	183:69	28	UVFLUSH [6UVRT, PACKET, UVS]		
	185		34UVS,C1,F,N,N,N,S,0,OFF,OFF,ON,OFF,OFF,NO,1,2C,05,00,00 [HVOFF]		



<b>Activity ID:</b>	Orbit 10	<b>OAPEL</b> TU10FANS	<b>SeqNo</b>	01-
<b>Title</b>	UVS/EUV FAR MIDNIGHT ANSA MAP, C10 INBD		<b>Instrument</b>	UVS
<b>Requestor</b>	UVS-MWG/S.STEPHENS	<b>Team</b>	UVS	<b>Working Group</b> MWG
<b>Time System</b>	CDS	<b>Load ID</b>	C10A	<b>Calendar Date</b> 09/16/97 <b>Week</b> 38
<b>Start</b>	JEE-CDS 00004070:00:0		97-259/02:35:02.600	JEE-002/20:35:13.333
<b>End</b>	JEE-CDS 00003586:00:0		97-259/10:44:25.267	JEE-002/12:25:50.666
<b>Duration</b>	00000484:00:0		000/08:09:22.667	000/08:09:22.667
<b>Top Label</b>	10TU10FANS01-			
<b>Bottom Label</b>	UVS/EUV RTS Torus			
<b>Plot Key</b>	UVS	<b>Type</b>	SCI	
<b>CDS Bytes</b>	378	<b>Report Options</b>	BOTH	<b>Scan Platform</b> Yes
<b>CDS Source</b>	OAP	<b>Spin State</b>	DUAL	<b>DMS</b> No
<b>Observation Objective</b>				
<p>UVS/EUV IO TORUS FAR MIDNIGHT ANSA MAP 1, C10 INBOUND (GLL-Jup = 32.8 Rj):                  From: 12.66 Rj at cone 90 (torus ribbon at 5.76 Rj, Sys III W Long 2)                  To: 9.48 Rj at fixed cone (Sys III W Long 289)                  UVFLUSH STRATEGY (17,712 bits per UVS or EUV PACKET; data rates 4.87 bps UVS or EUV):                  UVS and EUV deselected; 60-RIM UVFLUSHes needed to PACKET BOTH, after initial UVFLUSHes                  Total bits: 8 UVS + 8 EUV UVFLUSH PACKETS = 0.142 MB UVS + 0.142 MB EUV = 0.283 MB                  WAVELENGTHS (Angstroms):                  Emission lines: UVS (S+ 1259, S+ 4070), EUV (S++ 685, S+ 765, O+ 834)                  2POSN-22STEP N/G MINISCAN (UVS): N 4040.9-4098.7 (CTR 4071.2, STEP 436) [EVEN FRAMES],                  G 1239.8-1272.1 (CTR 1256.7, STEP</p>				
<b>Design Detail</b>				
PSID	RIM:mf	CDS	PA	
384BB	0	0	COMMENT [UVS RIM 0]	
61BA	1	37	LOOPER [LOOP PERIOD 120, NUM LOOPS 4]	
157BA	3	38	CMDRS (10+14*2) [PLAN DUR 61, EST UVS CMDS 2]	
349BA	3:69	28	UVFLUSH [6UVRT, DISCRD, BOTH]	
165BA	4	27	TARGET [CONE 90.00, CLOCK 94.67, POSITION SLEW ALLOCATION 4]	
	4		34UVS,D3,F,N,N,N,S,0,OFF,ON,ON,ON,OFF,NO,1,D5,4E,05,63 [22STEP N/G]	
349BB	62:69	112	UVFLUSH (28*4) [6UVRT, PACKET, BOTH]	
	64		34UVS,C1,F,N,N,N,S,0,OFF,ON,OFF,ON,OFF,NO,1,D8,06,00,08 [1STEP N/N]	
349BC	122:69	112	UVFLUSH (28*4) [6UVRT, PACKET, BOTH]	
...BI			... [REPEAT 3 ADDITIONAL TIMES]	
157BB	483	24	CMDRS (10+14*1) [PLAN DUR 1, EST UVS CMDS 1]	
	484		34UVS,C1,F,N,N,N,S,0,OFF,OFF,ON,OFF,OFF,NO,1,2C,05,00,00 [HVOFF]	

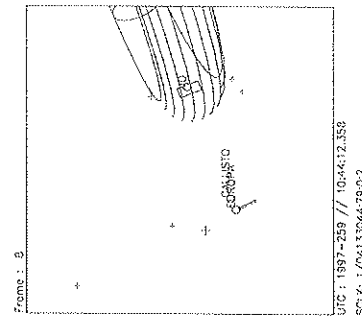
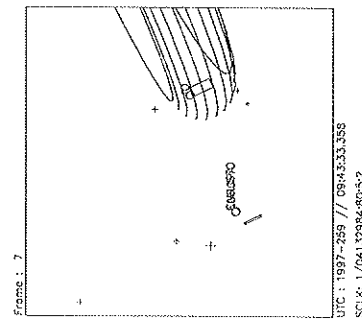
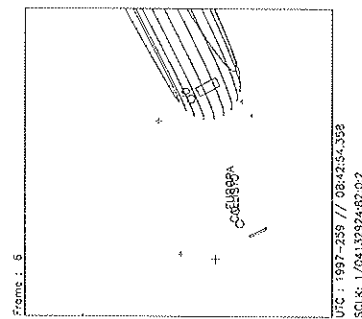
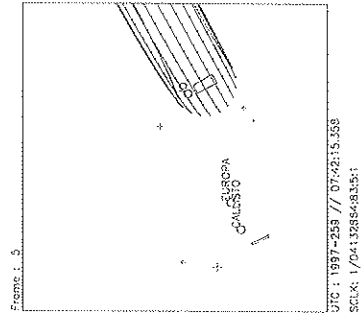
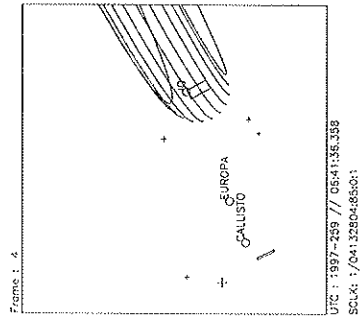
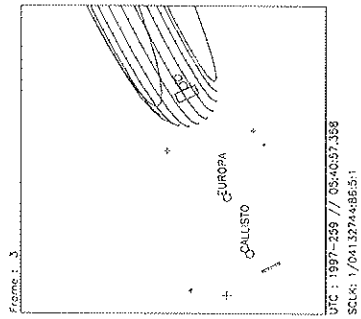
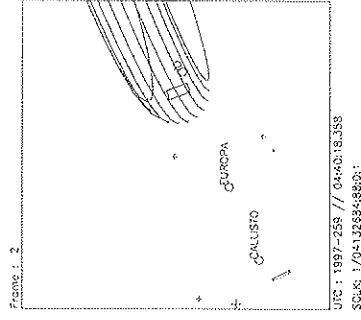
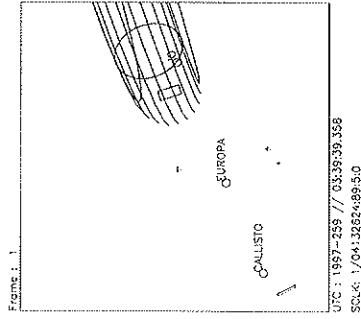
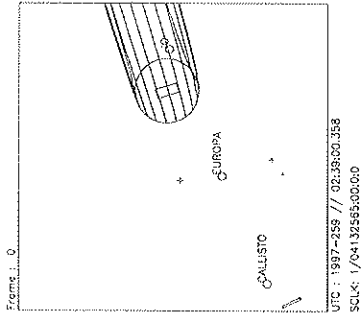

Start UTC\_TIME : 1997-259 // 02:39:00.358  
 End UTC\_TIME : 1997-259 // 10:44:20.341  
 Start SCLK : 1/04132565:00:0:0  
 Delta Time between FOV : 3639.000  
 FOVs : F Channel(0.1x0.4), N/G Channel(0.1x1.0)

Target Body : JUPITER  
 Target Cone/Clock : 68.36 / 94.62 Deg  
 S/C to Body Center : 2453110. Km ( 34.313071 Ri )  
 Z-axis Pointing ( Ro / Dec ) : 137.25 / 19.00 Deg

<b>Activity ID:</b> Orbit 10		OAPEL HU11XCAL		<b>SeqNo</b> 01-	
<b>Title</b>		UVS-EUV CROSS-CALIBRATION 1		<b>Instrument</b> UVS	
<b>Requestor</b>		UVS-MWG/S.STEPHENS		<b>Team</b> UVS	
				<b>Working Group</b> MWG	
<b>Time System</b>	CDS	<b>Load ID</b>	C10B	<b>Calendar Date</b>	10/31/97
				<b>Week</b>	44
<b>Start</b>	JEE+CDS 00060059:00:0		97-304/03:16:35.266		JEE+042/04:06:19.333
<b>End</b>	JEE+CDS 00061720:00:0		97-305/07:16:02.599		JEE+043/08:05:46.666
<b>Duration</b>	00001661:00:0		001/03:59:27.333		001/03:59:27.333
<b>Top Label</b>		10HU11XCAL01-			
<b>Bottom Label</b>		UVS-EUV Cross-Calibration			
<b>Plot Key</b>	UVS	<b>Type</b>	SCI		
<b>CDS Bytes</b>	580	<b>Report Options</b>	BOTH	<b>Scan Platform</b>	Yes
<b>CDS Source</b>	OAP	<b>Spin State</b>	DUAL	<b>DMS</b>	No
<b>Observation Objective</b>					
<p>UVS/EUV CROSS-CALIBRATION 1, E11 INBOUND (GLL-Jup = 57.0 Rj):                  H Lyman-alpha sky background                  UVFLUSH STRATEGY (17,712 bits per UVS or EUV PACKET; data rates 4.87 bps UVS or EUV):                  UVS and EUV deselected; 120-RIM UVFLUSHes needed to PACKET BOTH after initial DISCRDs                  Total bits: 2 UVS UVFLUSHes and 14 EUV UVFLUSHes = 0.035 MB UVS + 0.248 MB EUV = 0.283 MB                  [PLUS the cost of pausing PB for 217 RIMS ~ 0.18 MB]                  WAVELENGTHS (Angstroms):                  Emission lines: UVS (H 1216), EUV (H 1216)                  1POSN-66STEP G MINISCAN (UVS): G 1174.9-1275.2 (CTR 1225.9, STEP 61) [BOTH FRAMES]                  Strategy for MINISCANS: Alternate 30-RIM MINISCANS and 30-RIM HVOFFs for PWS quiet</p>					
<b>Design Detail</b>					
PSID	RIM:mf	CDS	PA		
384BR	0	0	COMMENT [UVS RIM 0]		
349OD	0:69	28	UVFLUSH [6UVRT, DISCRD, EUV]		
349OE	119:69	392	UVFLUSH (28*14) [6UVRT, PACKET, EUV]		
...OS			... [REPEAT 13 ADDITIONAL TIMES, EVERY 120 RIMS BUT PACKET BOTH ON 719:69 AND 839:69, AND LAST PACKET EUV (100 RIMS) AT 1659:69]		
176BO	594	15	SCITLM [PAUSE PLAYBACK]		
61BD	598	37	LOOPER [LOOP PERIOD 60, NUM LOOPS 4]		
157BQ	600	38	CMDRS (10+14*2) [PLAN DUR 2, EST UVS CMDS 2]		
349OI	600:69	28	UVFLUSH [6UVRT, DISCRD, UVS]		
165BN	601	27	TARGET [CONE 90.00, CLOCK 90.00, POSITION SLEW ALLOCATION 4]		
	601		34UVS, DD, F, N, N, N, S, 0, OFF, OFF, ON, ON, OFF, NO, 1, 48, 75, 00, 00 [66STEP G/G]		
	631		34UVS, C1, F, N, N, N, S, 0, OFF, OFF, ON, OFF, OFF, NO, 1, 2C, 05, 00, 00 [HVOFF]		
176BP	811	15	SCITLM [RESUME PLAYBACK]		

<b>Activity ID:</b>	Orbit 10	<b>OAPEL</b>	JU10AURA	<b>SeqNo</b>	01-
<b>Title</b>	UVS AURORA MAP 1, C10 INBOUND			<b>Instrument</b>	UVS
<b>Requestor</b>	UVS-MWG/S.STEPHENS	<b>Team</b>	UVS	<b>Working Group</b>	MWG
<b>Time System</b>	CDS	<b>Load ID</b>	C10A	<b>Calendar Date</b>	09/17/97
				<b>Week</b>	38
<b>Start</b>	JEE-CDS 00002366:00:0		97-260/07:17:58.600		JEE-001/15:52:17.333
<b>End</b>	JEE-CDS 00002180:00:0		97-260/10:26:02.600		JEE-001/12:44:13.333
<b>Duration</b>	00000186:00:0		000/03:08:04.000		000/03:08:04.000
<b>Top Label</b>	10JU10AURA01-				
<b>Bottom Label</b>	UVS RTS Aurora				
<b>Plot Key</b>	UVS	<b>Type</b>	SCI		
<b>CDS Bytes</b>	232	<b>Report Options</b>	BOTH	<b>Scan Platform</b>	Yes
<b>CDS Source</b>	OAP	<b>Spin State</b>	DUAL	<b>DMS</b>	No
<b>Observation Objective</b>					
<p>UVS JUPITER AURORA MAP 1, C10 INBOUND (GLL-Jup = 22.8 Rj):                  From: dark limb of Jupiter at cone 90, TARGETING sky background                  To: dark side of Jupiter at cone 90, TARGETING 60 deg South, 350 deg W Long                  To: dark side of Jupiter at cone &gt; 90, TARGETING 60 deg South, 350 deg W Long                  UVFLUSH STRATEGY (17,712 bits per UVS PACKET; data rate 4.87 bps UVS):                  UVS deselected; 60-RIM UVFLUSHes needed to PACKET UVS, after initial DISCRDs                  Total bits: 3 UVS UVFLUSH PACKETS = 0.053 MB UVS                  WAVELENGTHS (Angstroms):                  Emission lines: UVS (H 1253, H 1611), EUV (H 1253)                  F/G FULLSCAN (UVS): F 1616.5-3227.9 (CTR 2436.8, STEP 264) [EVEN FRAMES],                  G 1131.5-1920.1 (CTR 1534.7, STEP 264) [ODD FRAMES]</p>					
<b>Design Detail</b>					
PSID	RIM:mf	CDS PA			
384BF	0	0	COMMENT [UVS RIM 0]		
157BC	3	38	CMDRS (10+14*2) [PLAN DUR 183, EST UVS CMDS 2]		
349MD	3:69	28	UVFLUSH [GUVRT, DISCRD, UVS]		
165BB	4	27	TARGET [CONE 90.00, CLOCK 93.15, POSITION SLEW ALLOCATION 3:20]		
			34UVS,07,S,N,N,N,S,0,ON,OFF,ON,ON,OFF,NO,1,00,9C,01,2C [F/G FULLSCAN]		
349ME	62:69	28	UVFLUSH [GUVRT, PACKET, UVS]		
349MF	122:69	28	UVFLUSH [GUVRT, PACKET, UVS]		
349MG	125:69	28	UVFLUSH [GUVRT, DISCRD, UVS]		
165BC	126	27	TARGET [CONE 90.50, CLOCK 93.15, POSITION SLEW ALLOCATION 1]		
349MH	184:69	28	UVFLUSH [GUVRT, PACKET, UVS]		
	186		34UVS,C1,F,N,N,N,S,0,OFF,OFF,ON,OFF,OFF,NO,1,2C,05,00,00 [HVOFF]		

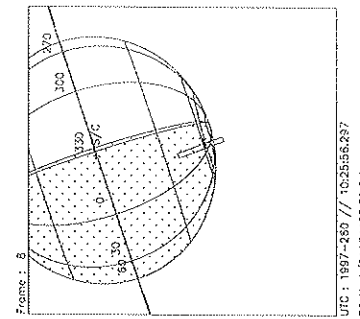
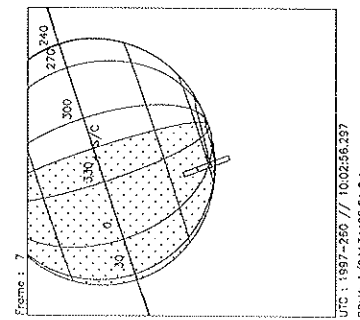
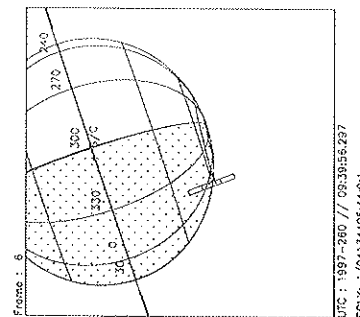
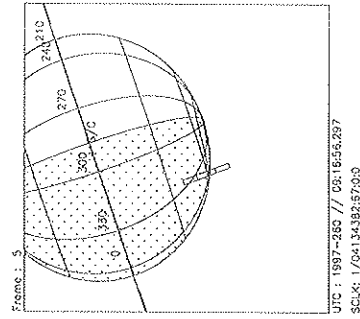
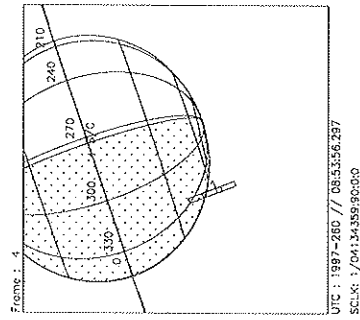
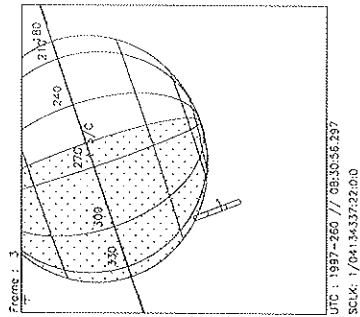
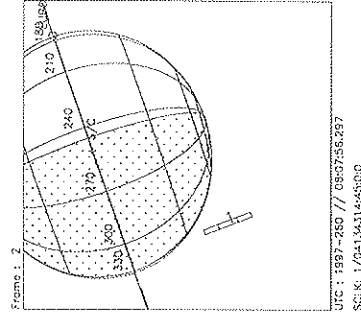
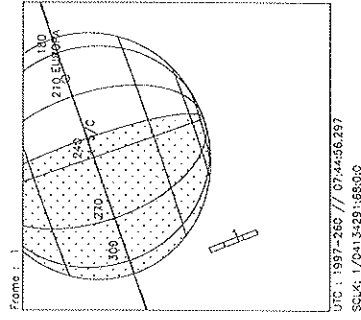
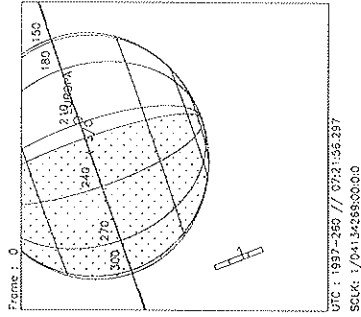

Start UTC\_TIME : 1997-260 // 07:21:56.297  
 End UTC\_TIME : 1997-260 // 10:25:57.623  
 Start SCLK : 1/04134269:00:00  
 Delta Time between FOV : 1380.000  
 FOVs : F Channel(0.1x0.4), N/G Channel(0.1x1.0)

Target Body : JUPITER  
 Target Cone/Clock : 87.09 / 95.14 Deg  
 S/C to Body Center : 1672523. Km ( 23.391748 Rj )  
 Z-axis Pointing ( Ra / Dec ) : 137.25 / 19.00 Deg

<b>Activity ID:</b>	Orbit 10	<b>OAPEL TU10NPRO</b>	<b>SeqNo</b>	01-
<b>Title</b>	UVS NOON ANSA PROFILE 1, C10 INBOUND		<b>Instrument</b>	UVS
<b>Requestor</b>	UVS-MWG/S.STEPHENS	<b>Team</b>	UVS	<b>Working Group</b> MWG
<b>Time System</b>	CDS	<b>Load ID</b>	C10A	<b>Calendar Date</b> 09/18/97 <b>Week</b> 38
<b>Start</b>	JEE-CDS 00001163:00:0		97-261/03:34:20.600	JEE-000/19:35:55.333
<b>End</b>	JEE-CDS 00000979:00:0		97-261/06:40:23.267	JEE-000/16:29:52.666
<b>Duration</b>	00000184:00:0		000/03:06:02.667	000/03:06:02.667
<b>Top Label</b>	10TU10NPRO01-			
<b>Bottom Label</b>	UVS RTS Torus			
<b>Plot Key</b>	UVS	<b>Type</b>	SCI	
<b>CDS Bytes</b>	205	<b>Report Options</b>	BOTH	<b>Scan Platform</b> Yes
<b>CDS Source</b>	OAP	<b>Spin State</b>	DUAL	<b>DMS</b> No
<b>Observation Objective</b>				
<div style="border: 1px solid black; padding: 5px;"> <p>UVS IO TORUS NOON ANSA PROFILE 1, C10 INBOUND (GLL-Jup = 14.2 Rj):                      From: 5.25 Rj at cone &gt; 90 (torus ribbon at 5.83 Rj, Sys III W Long 199)                      To: 6.40 Rj at fixed cone                      UVFLUSH STRATEGY (17,712 bits per UVS PACKET; data rate 4.87 bps UVS):                      UVS and EUV deselected; 60-RIM UVFLUSHes needed to PACKET UVS, after initial UVFLUSH                      Total bits: 3 UVS UVFLUSH PACKETS = 0.053 MB UVS                      WAVELENGTHS (Angstroms):                      Emission lines: UVS (S+ 1259, S+ 4070), EUV (S++ 685, S+ 765, O+ 834)                      2POSN-22STEP N/G MINISCAN (UVS): N 4040.9-4098.7 (CTR 4071.2, STEP 436) [EVEN FRAMES],                      G 1239.8-1272.1 (CTR 1256.7, STEP 81) [ODD FRAMES]                      2POSN-1STEP N/N MINISCAN (UVS): N 4049.2 (STEP 428) [EVEN</p> </div>				
<b>Design Detail</b>				
PSID	RIM:mf	CDS	PA	
384BG	0	0	COMMENT [UVS RIM 0]	
157BD	3	66	CMDRS (10+14*4) [PLAN DUR 181, EST UVS CMDS 4]	
349MI	3:69	28	UVFLUSH [6UVRT, DISCRD, UVS]	
165BD	4	27	TARGET [CONE 95.61, CLOCK 92.55, POSITION SLEW ALLOCATION 4]	
			34UVS, D3, F, N, N, N, S, 0, OFF, ON, ON, ON, OFF, NO, 1, D5, 4E, 05, 63 [22STEP N/G]	
349MJ	62:69	28	UVFLUSH [6UVRT, PACKET, UVS]	
			34UVS, C1, F, N, N, N, S, 0, OFF, ON, OFF, ON, OFF, NO, 1, D8, 06, 00, 08 [1STEP N/N]	
349MK	122:69	28	UVFLUSH [6UVRT, PACKET, UVS]	
			34UVS, D3, F, N, N, N, S, 0, OFF, ON, ON, ON, OFF, NO, 1, D5, 4E, 05, 63 [22STEP N/G]	
349ML	182:69	28	UVFLUSH [6UVRT, PACKET, UVS]	
			34UVS, C1, F, N, N, N, S, 0, OFF, OFF, ON, OFF, OFF, NO, 1, 2C, 05, 00, 00 [HVOFF]	

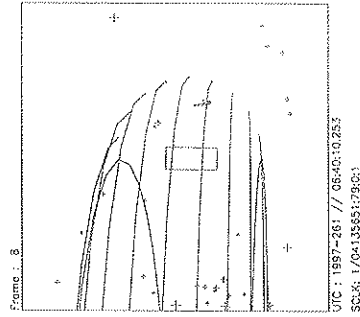
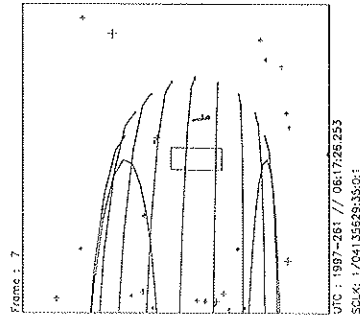
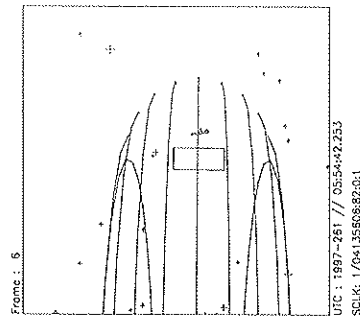
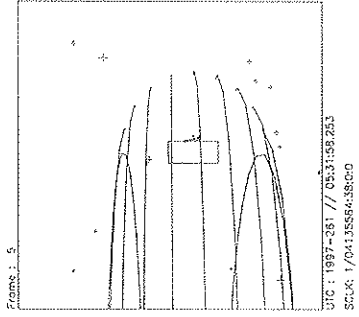
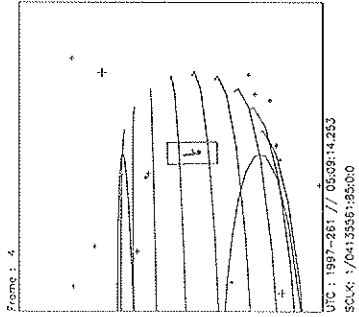
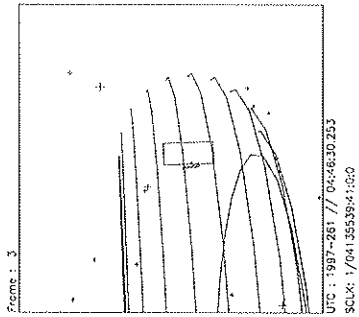
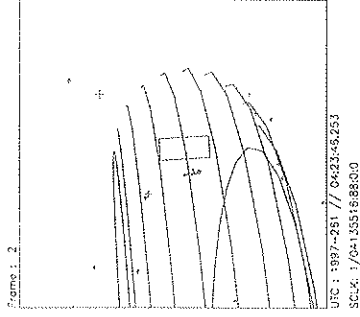
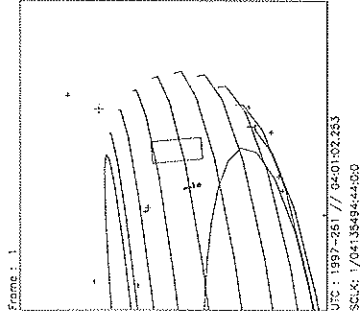
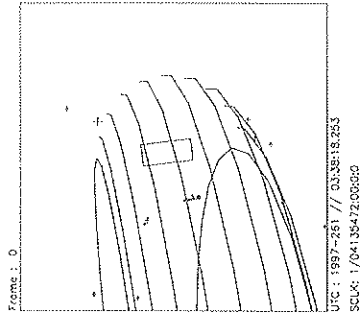

Start UTC\_TIME : 1997-261 // 03:38:18.253  
 End UTC\_TIME : 1997-261 // 06:40:18.247  
 Start SCLK : 1/04135472:00:00  
 Delta Time between FOV : 1364.000  
 FOVs : F Channel(0.1x0.4), N/G Channel(0.1x1.0)

Target Body : JUPITER  
 Target Cone/Clock : 116.04 / 96.10 Deg  
 S/C to Body Center : 1061581. Km ( 14.848942 RJ )  
 Z-axis Pointing ( Ra / Dec ) : 137.21 / 19.00 Deg

<b>Activity ID:</b> Orbit 10		<b>OAPEL</b> TU10MPRO		<b>SeqNo</b> 01-	
<b>Title</b>	UVS MDNT ANSA PROFILE 1, C10 OUTBOUND			<b>Instrument</b>	UVS
<b>Requestor</b>	UVS-MWG/S.STEPHENS	<b>Team</b>	UVS	<b>Working Group</b>	MWG
<b>Time System</b>	CDS	<b>Load ID</b>	C10A	<b>Calendar Date</b>	09/20/97
		<b>Week</b>			38
<b>Start</b>	JEE+CDS 00001965:00:0		97-263/08:17:05.933		JEE+001/09:06:50.000
<b>End</b>	JEE+CDS 00002329:00:0		97-263/14:25:08.599		JEE+001/15:14:52.666
<b>Duration</b>	00000364:00:0		000/06:08:02.666		000/06:08:02.666
<b>Top Label</b>	10TU10MPRO01-				
<b>Bottom Label</b>	UVS RTS Torus				
<b>Plot Key</b>	UVS	<b>Type</b>	SCI		
<b>CDS Bytes</b>	322	<b>Report Options</b>	BOTH	<b>Scan Platform</b>	Yes
<b>CDS Source</b>	OAP	<b>Spin State</b>	DUAL	<b>DMS</b>	No
<b>Observation Objective</b>					
<div style="border: 1px solid black; padding: 5px;"> <p>UVS IO TORUS MIDNIGHT ANSA PROFILE 1, C10 OUTBOUND (GLL-Jup = 21.9 Rj):                      From: 4.43 Rj at cone &gt; 90 (torus ribbon at 5.92 Rj, Sys III W Long 170)                      To: 7.40 Rj at fixed cone                      UVFLUSH STRATEGY (17,712 bits per UVS PACKET; data rate 4.87 bps UVS):                      UVS and EUV deselected; 60-RIM UVFLUSHes needed to PACKET UVS, after initial UVFLUSH                      Total bits: 6 UVS UVFLUSH PACKETS = 0.106 MB UVS                      WAVELENGTHS (Angstroms):                      Emission lines: UVS (S+ 1259, S+ 4070), EUV (S++ 685, S+ 765, O+ 834)                      2POSN-22STEP N/G MINISCAN (UVS): N 4040.9-4098.7 (CTR 4071.2, STEP 436) [EVEN FRAMES],                      G 1239.8-1272.1 (CTR 1256.7, STEP 81) [ODD FRAMES]</p> </div>					
<b>Design Detail</b>					
PSID	RIM:mf	CDS PA			
384BH	0	0	COMMENT [UVS RIM 0]		
61BB	1	37	LOOPER [LOOP PERIOD 120, NUM LOOPS 3]		
157BE	3	38	CMDRS (10+14*2) [PLAN DUR 61, EST UVS CMDS 2]		
349MM	3:69	28	UVFLUSH [6UVRT, DISCRD, BOTH]		
165BE	4	27	TARGET [CONE 98.79, CLOCK 281.70, POSITION SLEW ALLOCATION 4]		
	4		34UVS,D3,F,N,N,N,S,0,OFF,ON,ON,OFF,NO,1,D5,4E,05,63 [22STEP N/G]		
349MN	62:69	84	UVFLUSH (28*3) [6UVRT, PACKET, BOTH]		
	64		34UVS,C1,F,N,N,N,S,0,OFF,ON,OFF,ON,OFF,NO,1,D8,06,00,08 [1STEP N/N]		
349MO	122:69	84	UVFLUSH (28*3) [6UVRT, PACKET, BOTH]		
...MS			... [REPEAT 2 ADDITIONAL TIMES]		
157BF	363	24	CMDRS (10+14*1) [PLAN DUR 1, EST UVS CMDS 1]		
	364		34UVS,C1,F,N,N,N,S,0,OFF,OFF,ON,OFF,OFF,NO,1,2C,05,00,00 [HVOFF]		



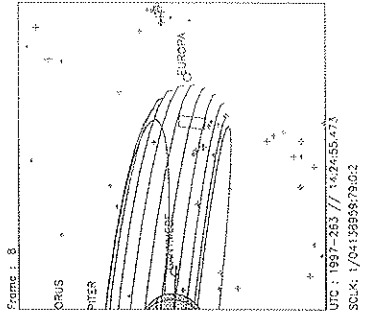
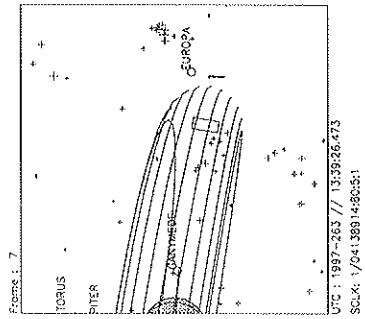
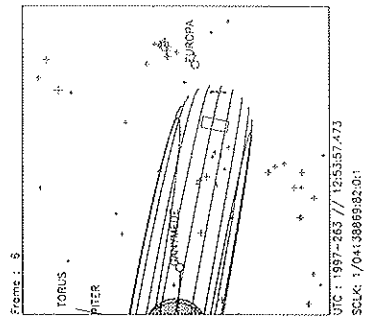
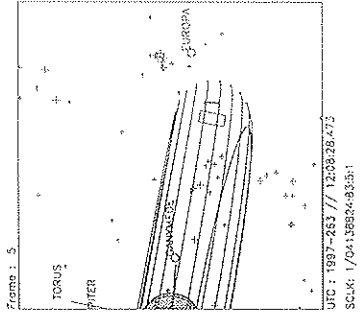
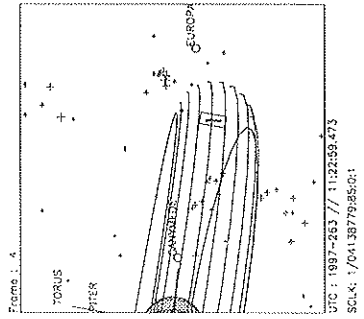
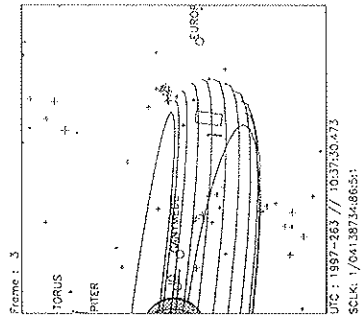
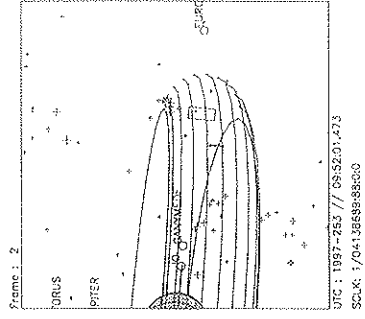
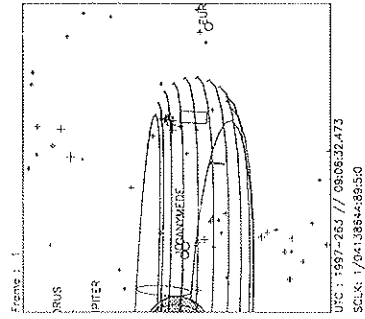
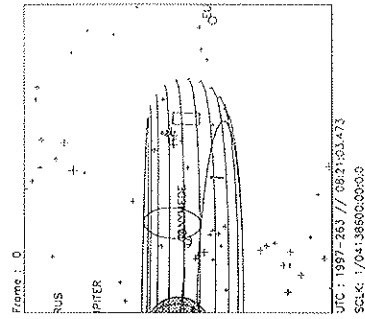

Start UTC\_TIME : 1997-263 // 08:21:03.473  
 End UTC\_TIME : 1997-263 // 14:25:03.460  
 Start SCLK : 1/04138600:00:0.0  
 Delta Time between FOV : 2729.000  
 FOVs : F Channel(0.1x0.4), N/G Channel(0.1x1.0)

Target Body : JUPITER  
 Target Cone/Clock : 60.03/276.27 Deg  
 S/C to Body Center : 1476814. Km ( 20.657056 Ri )  
 Z-axis Pointing ( Ro / Dec ) : 137.25 / 19.00 Deg