

<b>Activity ID:</b> Orbit E6	<b>OAPEL</b> IUIODARK	<b>SeqNo</b> 01-
<b>Title</b>	UVS IO ECLIPSE (N-Channel Dark Obs.)	<b>Instrument</b> UVS
<b>Requestor</b>	UVS-SWG/K.NAVIAUX 37740	<b>Team</b> UVS
		<b>Working Group</b> SWG
<b>Time System</b> CDS	<b>Load ID</b> E6A	<b>Calendar Date</b> 02/19/97
		<b>Week</b> 8
<b>Start</b>	JEE-CDS 00001905:00:0	97-050/12:47:44.606
		JEE-001/08:06:10.000
<b>End</b>	JEE-CDS 00001872:00:0	97-050/13:21:06.606
		JEE-001/07:32:48.000
<b>Duration</b>	00000033:00:0	000/00:33:22.000
		000/00:33:22.000

<b>Top Label</b>	E6IUIODARK01-		
<b>Bottom Label</b>	(real-time)		
<b>Plot Key</b>	UVS	<b>Type</b>	SCI
<b>CDS Bytes</b>	206	<b>Report Options</b>	BOTH
		<b>Scan Platform</b>	Yes
<b>CDS Source</b>	OAP	<b>Spin State</b>	DUAL
		<b>DMS</b>	No

**Observation Objective**

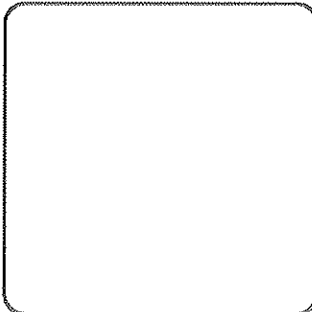

UVS real-time Io Eclipse observation. Obtain UVS N-Channel data (2800-4300 Å) while Io is being eclipsed by Jupiter. Data will be used to characterize the lower atmospheric UV airglow emissions of Io while in eclipse.

E6IUIODARK01- = Io eclipse measurement. 1 scan-platform drift across Io in real-time (15 RIM 3-sigma drift rate) using the UVS 10 bps RTS rate. The drift will include 15 RIMs HV On / 15 RIM HV Off for PWS time sharing.

UVS Configuration = N-Channel Full Scans

**Design Detail**

CDS	RIM	Command	Parameters	Psid
28	001	UVFLUSH	DISCRD,UVS	(CA)
36	003	TARGET	(3 RIM Posn_Slew)	(CE)
38	002	CMDRS		(CE)
	003	1	34UVS,07,S,N,N,N,S,0, ON,OFF, ON, ON,OFF,NOOVR,1,00,9C,01,2C	← NO!
	018	16	34UVS,C1,F,N,N,N,S,0,OFF,OFF, ON,OFF,OFF,NOOVR,1,2C,05,00,00	
28	031	UVFLUSH	PACKET,UVS	(CB)

*was really 07,S,N,N,N,S,0, ON,OFF,NOOVR,1,2C,9D,00,00*

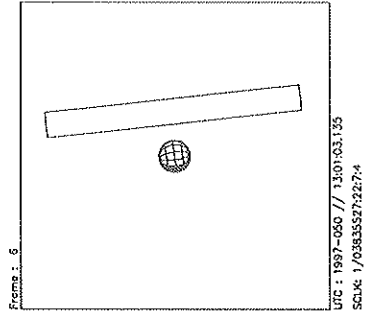
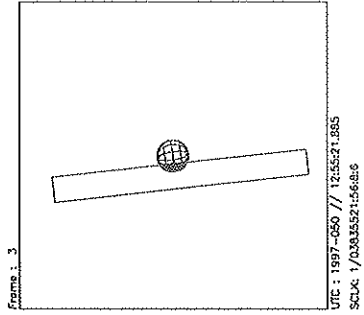
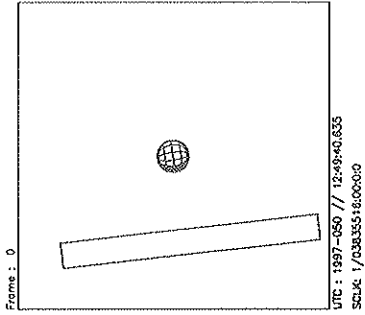

Start UTC\_TIME : 1997-050 // 12:49:40.635  
No End Time :  
Start SCLK : 1/03835516:00:00

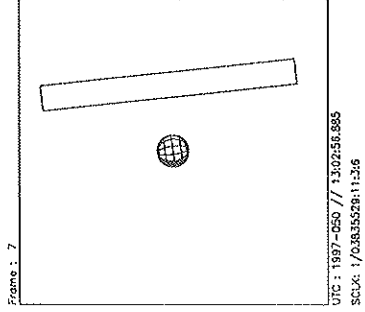
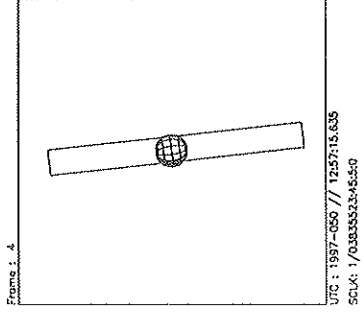
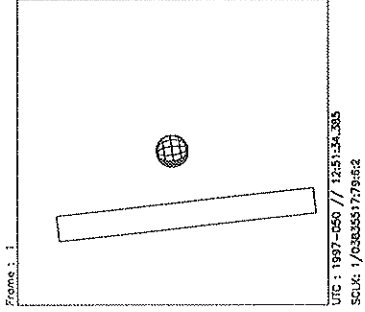

Target Body : IO  
Target Cone/Clock : 122.26 / 93.65 Deg  
S/C to Body Center : 1689224. Km ( 925.93199 RI )  
Z-axis Pointing ( Ro / Dec ) : 130.30 / 18.80 Deg

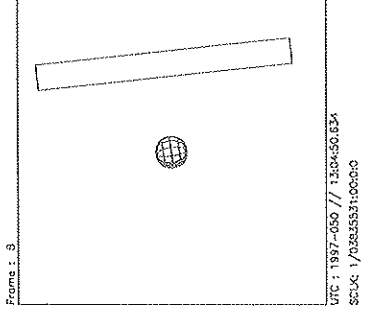
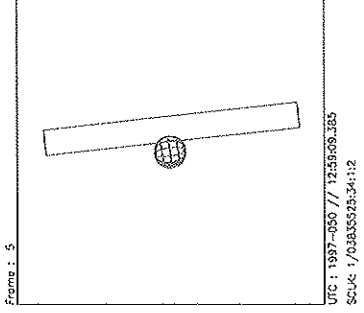
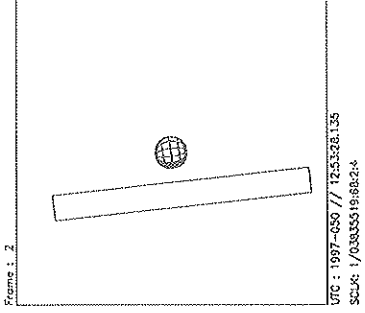

<b>Activity ID:</b> Orbit E6		<b>CAPEL IUIECLPS</b>		<b>SeqNo</b> 03-	
<b>Title</b>		UVS IO ECLIPSE (BEFORE-EGRESS)		<b>Instrument</b> UVS	
<b>Requestor</b>		UVS-SWG/K.NAVIAUX 37740		<b>Team</b> UVS	
				<b>Working Group</b> SWG	
<b>Time System</b> CDS		<b>Load ID</b> E6A		<b>Calendar Date</b> 02/19/97	
				<b>Week</b> 8	
<b>Start</b>		JEE-CDS 00001833:00:0		97-050/14:00:32.606	
				JEE-001/06:53:22.000	
<b>End</b>		JEE-CDS 00001799:00:0		97-050/14:34:55.606	
				JEE-001/06:18:59.000	
<b>Duration</b>		00000034:00:0		000/00:34:23.000	
				000/00:34:23.000	
<b>Top Label</b>		E6IUIECLPS03-			
<b>Bottom Label</b>		(real-time)			
<b>Plot Key</b>		UVS		<b>Type</b> SCI	
<b>CDS Bytes</b>		168		<b>Report Options</b> BOTH	
				<b>Scan Platform</b> Yes	
<b>CDS Source</b>		OAP		<b>Spin State</b> DUAL	
				<b>DMS</b> No	
<b>Observation Objective</b>					
<div style="border: 1px solid black; padding: 5px;"> <p>UVS real-time Io Eclipse observation. Characterize the change in the lower atmospheric UV airglow emissions as Io exits eclipse. Determine if the source of the change is due to: 1) a change in the lower atmospheric composition as it cools (ie. SO2 condensation); or 2) a potential change in the excitation mechanism if solar photoexcitation is dominant over particle impact.</p> <p>E6IUIECLPS03- = Io eclipse before egress measurement. 1 scan-platform drift across Io in real-time (15 RIM 3-sigma drift rate) just prior to the satellite leaving Jupiter's eclipse using the UVS 10bps RTS rate. Only 1 drift will be done prior to eclipse ingress due to PWS time sharing. Each drift will include 15 RIMS HV On / 15 RIMS HV Off for PWS time sharing. The corresponding ingress measurements (E6IUIECLPS01- &amp; 02-) were deleted due to time conflicts with the E6 AWG Feature Track observations.</p> <p style="text-align: center;">UVS Configuration = F/G Full Scans</p> </div>					
<b>Design Detail</b>					
CDS RIM Command Parameters				PSID	
-----				-----	
28	002+UVFLUSH	DISCRD, UVS		(CC)	
36	004 TARGET	(4 RIM Posn_slew)		(CF)	
38	003 CMDRS			(CF)	
	004	1 34UVS, 07, S, N, N, N, S, 0,	ON, OFF,	ON,	ON, OFF, NOOVR, 1, 00, 9C, 01, 2C
	019	16 34UVS, C1, F, N, N, N, S, 0,	OFF, OFF,	ON,	OFF, OFF, NOOVR, 1, 2C, 05, 00, 00
28	018+UVFLUSH	PACKET, UVS		(CD)	

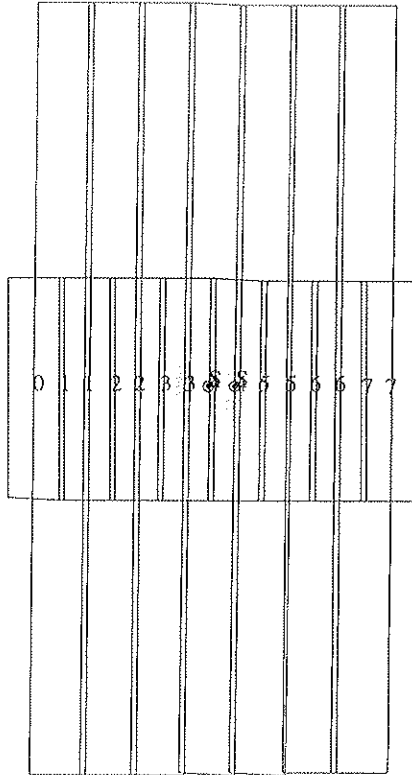

---

ESIGN G2.0 jaiel:12/ 8/1996 15:48: 4

FILE:P.E6IUIECLPS03

TARGET BODY : IO

INT:m.E6IUIECLPS03

.PH:/DATA/NAVIO/T-961107-TOUR.NS

ERIAPSIS:

THINNING: :UVS 1

TART:JEE 97-051/20:52:52.600 -CDS 1829:00:0 BODY PLOT TIME:TARGET-TIME D= 0 S= 0.050

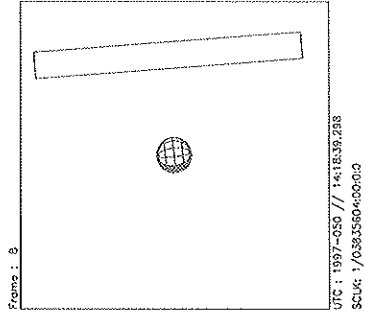
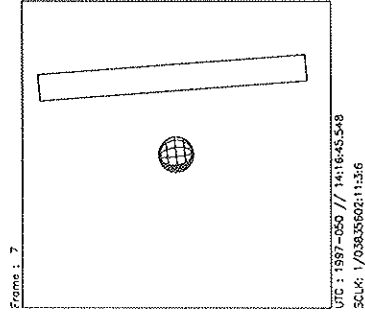
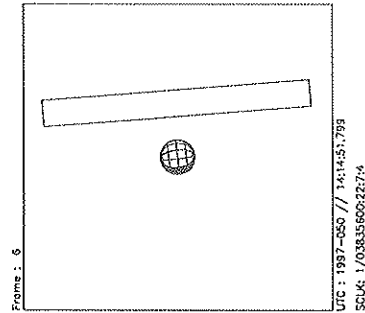
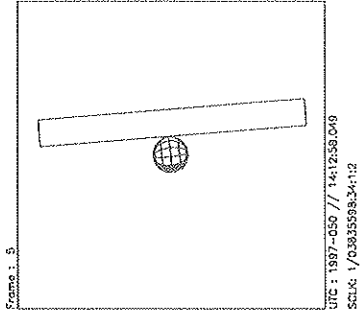
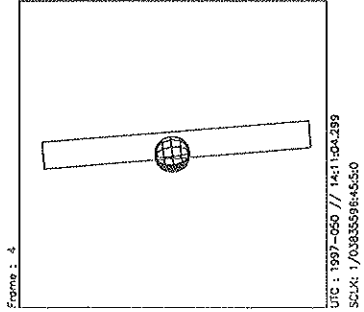
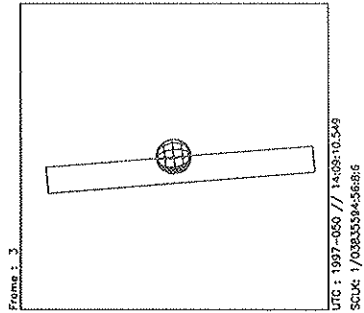
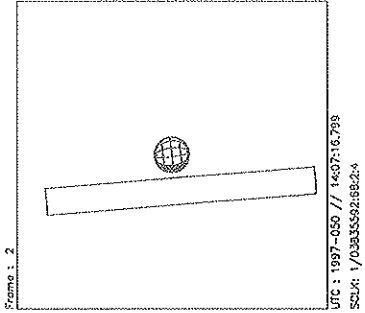
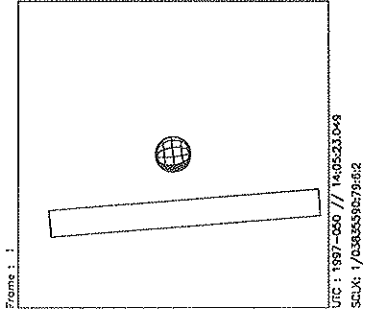
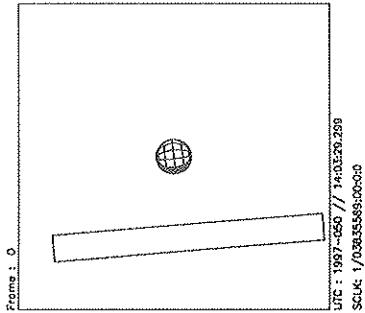

Start UTC\_TIME : 1997-050 // 14:03:29.299  
No End Time :  
Start SCLK : 1/03835589:00:0:0

Target Body : IO  
Target Cone/Clock : 125.58 / 93.63 Deg  
S/C to Body Center : 1606142. Km ( 880.39132 Ri )  
Z-axis Pointing ( Ro / Dec ) : 130.30 / 18.80 Deg

<b>Activity ID:</b> Orbit E6		OAPEL IUIECLPS		<b>SeqNo</b> 04-	
<b>Title</b>		UVS IO ECLIPSE (AFTER-EGRESS)		<b>Instrument</b> UVS	
<b>Requestor</b>		UVS-SWG/K.NAVIAUX 37740		<b>Team</b> UVS	
				<b>Working Group</b> SWG	
<b>Time System</b>	CDS	<b>Load ID</b>	E6A	<b>Calendar Date</b>	02/19/97
				<b>Week</b>	8
<b>Start</b>	JEE-CDS 00001781:00:0		97-050/14:53:07.606		JEE-001/06:00:47.000
<b>End</b>	JEE-CDS 00001746:00:0		97-050/15:28:30.606		JEE-001/05:25:24.000
<b>Duration</b>	00000035:00:0		000/00:35:23.000		000/00:35:23.000
<b>Top Label</b>		E6IUIECLPS04-			
<b>Bottom Label</b>		(real-time)			
<b>Plot Key</b>	UVS	<b>Type</b>	SCI		
<b>CDS Bytes</b>	168	<b>Report Options</b>	BOTH	<b>Scan Platform</b>	Yes
<b>CDS Source</b>	OAP	<b>Spin State</b>	DUAL	<b>DMS</b>	No
<b>Observation Objective</b>					
<div style="border: 1px solid black; padding: 5px;"> <p>UVS real-time Io Eclipse observation. Characterize the change in the lower atmospheric UV airglow emissions as Io exits eclipse. Determine if the source of the change is due to: 1) a change in the lower atmospheric composition as it cools (ie. SO2 condensation); or 2) a potential change in the excitation mechanism if solar photoexcitation is dominant over particle impact.</p> <p>E6IUIECLPS04- = Io eclipse after egress measurement. 1 scan-platform drift across Io in real-time (15 RIM 3-sigma drift rate) just prior to the satellite leaving Jupiter's eclipse using the UVS 10bps RTS rate. Only 1 drift will be done prior to eclipse ingress due to PWS time sharing. Each drift will include 15 RIMs HV On / 15 RIMs HV Off for PWS time sharing. The corresponding ingress measurements (E6IUIECLPS01- &amp; 02-) were deleted due to time conflicts with the E6 AWG Feature Track observations.</p> <p style="text-align: center;">UVS Configuration = F/G Full Scans</p> </div>					
<b>Design Detail</b>					
CDS RIM Command Parameters					PSID
28 002+UVFLUSH DISCRD,UVS					(CE)
36 004 TARGET (4 RIM Posn_slew)					(CG)
38 003 CMDRS					(CG)
004 1 34UVS,07,S,N,N,N,S,0,	ON,OFF, ON, ON,OFF,NOOVR,1,00,9C,01,2C				
019 16 34UVS,C1,F,N,N,N,S,0,	OFF,OFF, ON,OFF,OFF,NOOVR,1,2C,05,00,00				
28 018+UVFLUSH PACKET,UVS					(CF)

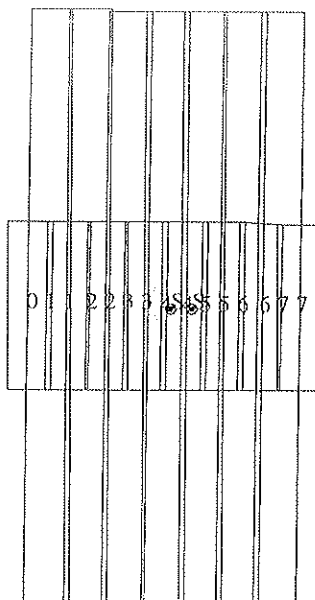

---

ESIGN G2.0 jaiel:12/ 2/1996 14:57:50

FILE:P.E6IUIECLPS04

TARGET BODY : IO

INFILE:m.E6IUIECLPS04

FILE:PH:/DATA/NAVIO/T-961107-TOUR.NS

ERIAPSIS:

THINNING: :UVS 1

TART:JEE 97-051/20:52:52.600 -CDS 1777:00:0 BODY PLOT TIME:TARGET-TIME D= 0 S= 0.040

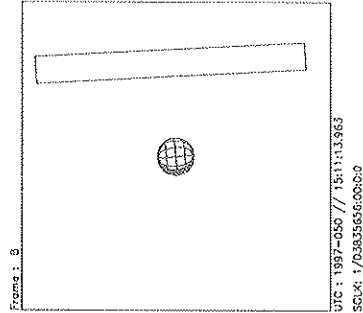
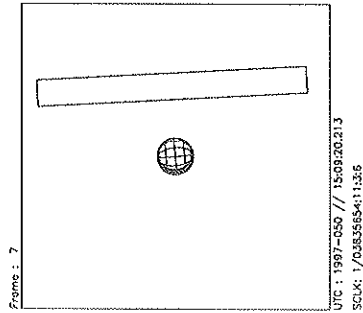
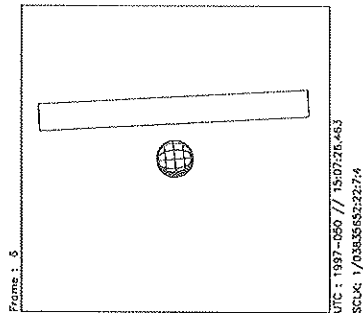
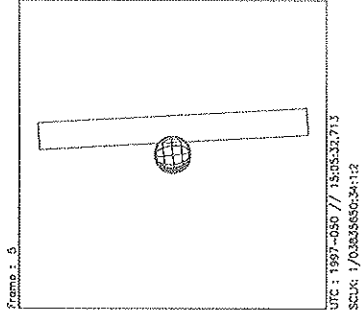
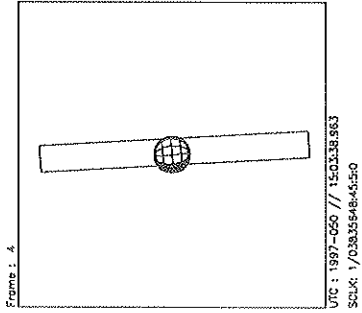
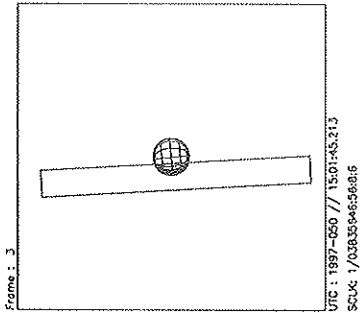
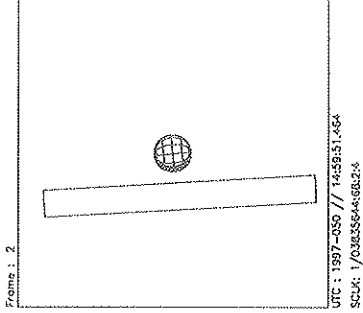
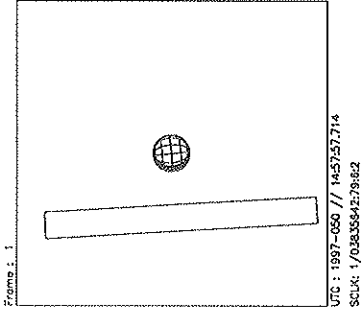
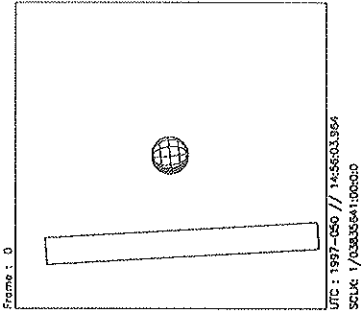

Start UTC\_TIME : 1997-050 // 14:56:03.964  
No End Time :  
Start SCLK : 1/03835641:00:0:0

Target Body : IO  
Target Cone/Clock : 127.93 / 93.61 Deg  
S/C to Body Center : 154420. Km ( 846.44386 Ri )  
Z-axis Pointing ( Ro / Dec ) : 130.30 / 18.80 Deg



<b>Activity ID:</b> Orbit E6		OAPEL IUNTRLCL		<b>SeqNo</b> 01-	
<b>Title</b>		UVS IO NEUTRAL CLOUD		<b>Instrument</b> UVS	
<b>Requestor</b>		UVS-SWG/LAIBLLO 30523		<b>Team</b> UVS	
				<b>Working Group</b> SWG	
<b>Time System</b> CDS		<b>Load ID</b>		<b>Calendar Date</b> 02/20/97	
				<b>Week</b> 8	
<b>Start</b>		JEE-CDS 00001210:00:0		97-051/00:29:25.934	
				JEE-000/20:23:26.666	
<b>End</b>		JEE-CDS 00001065:00:0		97-051/02:56:02.600	
				JEE-000/17:56:50.000	
<b>Duration</b>		00000145:00:0		000/02:26:36.666	
				000/02:26:36.666	
<b>Top Label</b>		E6IUNTRLCL01-			
<b>Bottom Label</b>		(real-time)			
<b>Plot Key</b>		UVS		<b>Type</b> SCI	
<b>CDS Bytes</b>		374		<b>Report Options</b> BOTH	
				<b>Scan Platform</b> Yes	
<b>CDS Source</b>		OAP		<b>Spin State</b> DUAL	
				<b>DMS</b> No	
<b>Observation Objective</b>					
<div style="border: 1px solid black; width: 150px; height: 100px; display: inline-block; vertical-align: top; margin-right: 10px;"></div> <p>UVS real-time Io Neutral Cloud observation. Determine the composition and time variation of the ionized Io neutral cloud (SO<sub>2</sub>, SO, O, S, K, Na) to assist in the modeling of the Io plasma torus and Io atmosphere.</p> <p>Target s/p at 7 locations in the Io orbit plane:          +27 Io diameters away from Io (+ = away from Jupiter).          +10 Io diameters          +4          +2          0 Io-centered          -2          -4</p> <p>Target motion compensation employed to integrate for 19 RIMS at each position Lyman alpha          16-step width both odd and even frames.</p>					
<b>Design Detail</b>					
CDS RIM	Command	Parameter		PSID	
36	004	TARGET (4 RIM Posn_Slew)		(CH)	
28	002	+UVFLUSH DISCRD, UVS		(CO)	
94	003	CMDRS		(CH)	
	004	1 34UVS, D1, F, N, N, N, S, 0, OFF, OFF,	ON, ON, OFF, NOOVR, 1, 5A, 45, 00, 00		1215.1/1215
.1	145	142 34UVS, C1, F, N, N, N, S, 0, OFF, OFF,	ON, OFF, OFF, NOOVR, 1, 2C, 05, 00, 00		HV Off
28	022	+UVFLUSH PACKET, UVS		(CP)	
28	025	+UVFLUSH DISCRD, UVS		(CO)	
36	026	TARGET (3 RIM Posn_Slew)		(CI)	
28	044	+UVFLUSH PACKET, UVS		(CP)	
36	046	TARGET (1 RIM Posn_Slew)		(CJ)	
28	064	+UVFLUSH PACKET, UVS		(CQ)	
36	066	TARGET (1 RIM Posn_Slew)		(CK)	
28	084	+UVFLUSH PACKET, UVS		(CR)	
36	086	TARGET (1 RIM Posn_Slew)		(CL)	
28	104	+UVFLUSH PACKET, UVS		(CS)	
36	106	TARGET (1 RIM Posn_Slew)		(CM)	
28	124	+UVFLUSH PACKET, UVS		(CR)	
36	126	TARGET (1 RIM Posn_Slew)		(CN)	



x

x

x

x



ESIGN G2.0 jael: 1/ 2/1997 10:22:54

FILE:P.E6IUNTRLCL01

TARGET BODY : IO

INFILE:m.E6IUNTRLCL01

PH:/DATA/NAVIO/T-961107-TOUR.NS

ERIAPSIS:

TART:JEE 97-051/20:52:52.600 -CDS 1206:00:0

165CI:TT= 0 TMC= 1 C= 45.38 XC= 0.20 BS= 0/3618 TC= 9  
 A= 546 pD= 3458 SR=17.450 RA50=281.18 DEC50=-24.39 cone=152.41 clock= 93.77

165CJ:TT= 0 TMC= 1 C= 18.15 XC= 0.20 BS= 0/7258 TC= 9  
 A= 182 pD= 3458 SR=17.450 RA50=279.90 DEC50=-24.49 cone=151.24 clock= 93.80

165CK:TT= 0 TMC= 1 C= 9.08 XC= 0.20 BS= 0/0898 TC= 3  
 A= 182 pD= 3458 SR=17.450 RA50=279.71 DEC50=-24.49 cone=151.07 clock= 93.83

165CL:TT= 0 TMC= 1 C= 0.00 XC= 0.00 BS= 0/4538 TC= 9  
 A= 182 pD= 3458 SR=17.450 RA50=279.48 DEC50=-24.51 cone=150.86 clock= 93.84

165CM:TT= 0 TMC= 1 C= -9.08 XC= 0.00 BS= 0/8178 TC= 9  
 A= 182 pD= 3458 SR=17.450 RA50=279.20 DEC50=-24.51 cone=150.60 clock= 93.87

165CN:TT= 0 TMC= 1 C= -18.15 XC= 0.20 BS= 0/1818 TC= 9  
 A= 182 pD= 3458 SR=17.450 RA50=278.86 DEC50=-24.51 cone=150.30 clock= 93.93

THINNING: :UVS 1

BODY PLOT TIME:END-TIME D= 3458 S= 0.018

*EBARC  
DUNFELLO*

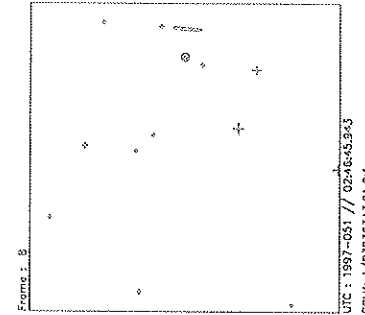
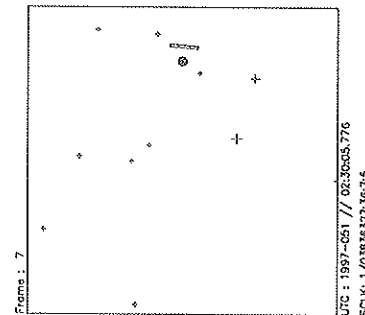
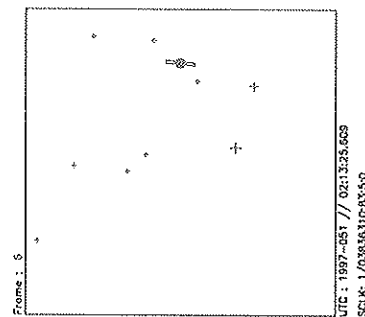
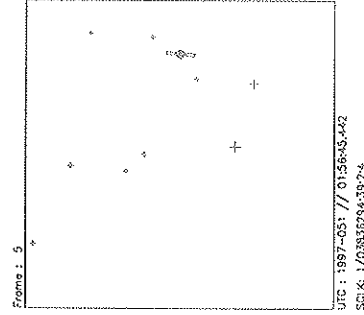
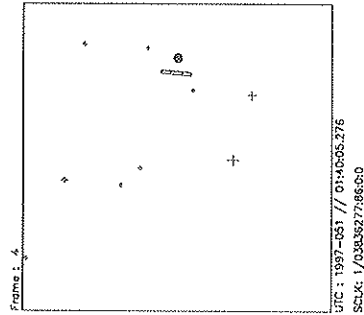
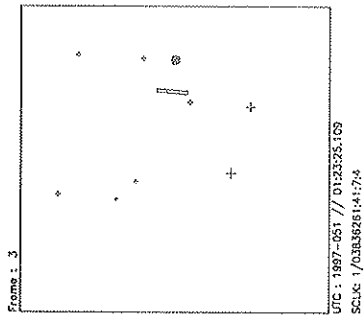
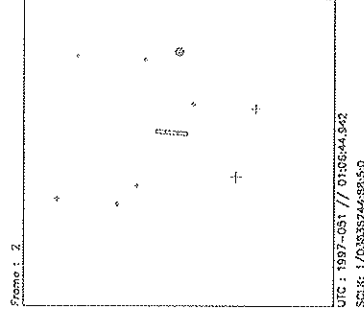
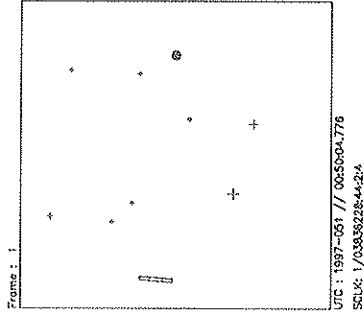
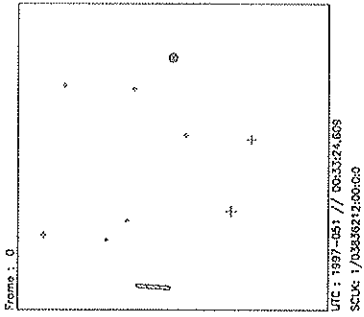

Start UTC\_TIME : 1997-051 // 00:33:24.609  
 End UTC\_TIME : 1997-051 // 02:48:53.937  
 Start SCLK : 1/03836212:00:00  
 Delta Time between FOV : 1000.167  
 FOVs : F Channel(0.1x0.4), N/G Channel(0.5x0.5)

Target Body : IQ  
 Target Cone/Clock : 149.34 / 93.70 Deg  
 S/C to Body Center : 821293.9 Km ( 450.18437 Ri )  
 Z-axis Pointing ( Ro / Dec ) : 130.50 / 18.80 Deg

<b>Activity ID:</b> Orbit E6		OAPEL EUTERINC		<b>SeqNo</b> 01+	
<b>Title</b>		Europa Terra Incognita		<b>Instrument</b> UVS	
<b>Requestor</b>		UVS-MWG/I. AIBLLO X37737		<b>Team</b> UVS	
				<b>Working Group</b> SWG	
<b>Time System</b> CDS		<b>Load ID</b>		<b>Calendar Date</b> 02/20/97	
				<b>Week</b> 8	
<b>Start</b>		EEE-CDS 00000298:00:0		97-051/12:02:02.667	
				EEE-000/05:01:18.666	
<b>End</b>		EEE-CDS 00000260:00:0		97-051/12:40:28.000	
				EEE-000/04:22:53.333	
<b>Duration</b>		00000038:00:0		000/00:38:25.333	
				000/00:38:25.333	
<b>Top Label</b>		E6EUTERINC01+			
<b>Bottom Label</b>		NIMS ride along			
<b>Plot Key</b>		UVS		<b>Type</b> SCI	
<b>CDS Bytes</b>		0		<b>Report Options</b> BOTH	
				<b>Scan Platform</b> No	
<b>CDS Source</b>		OAP		<b>Spln State</b> DUAL	
				<b>DMS</b> No	
<b>Observation Objective</b>					
Part of Global Mosaic of Europa, longitudes 160 to 240 degrees.					
Take 1 Rim of real-time data from RIMS					
4- 5 +54 deg lat./200-177 deg long.      Coordinates represent					
center of F-channel FOV					
14-15 +13 deg lat./193-180 deg long.					
23-24 -18 deg lat./195-182 deg long.					
31-32 -58 deg lat./206-184 deg long.					
<b>Design Detail</b>					
CDS	RIM	COMMAND			
28	001+	UVFLUSH	DISCRD	UVS	
28	004+	UVFLUSH	PACKET	UVS	
28	013+	UVFLUSH	DISCRD	UVS	
28	015+	UVFLUSH	PACKET	UVS	
28	023+	UVFLUSH	PACKET	UVS	
28	026+	UVFLUSH	DISCRD	UVS	
28	028+	UVFLUSH	PACKET	UVS	

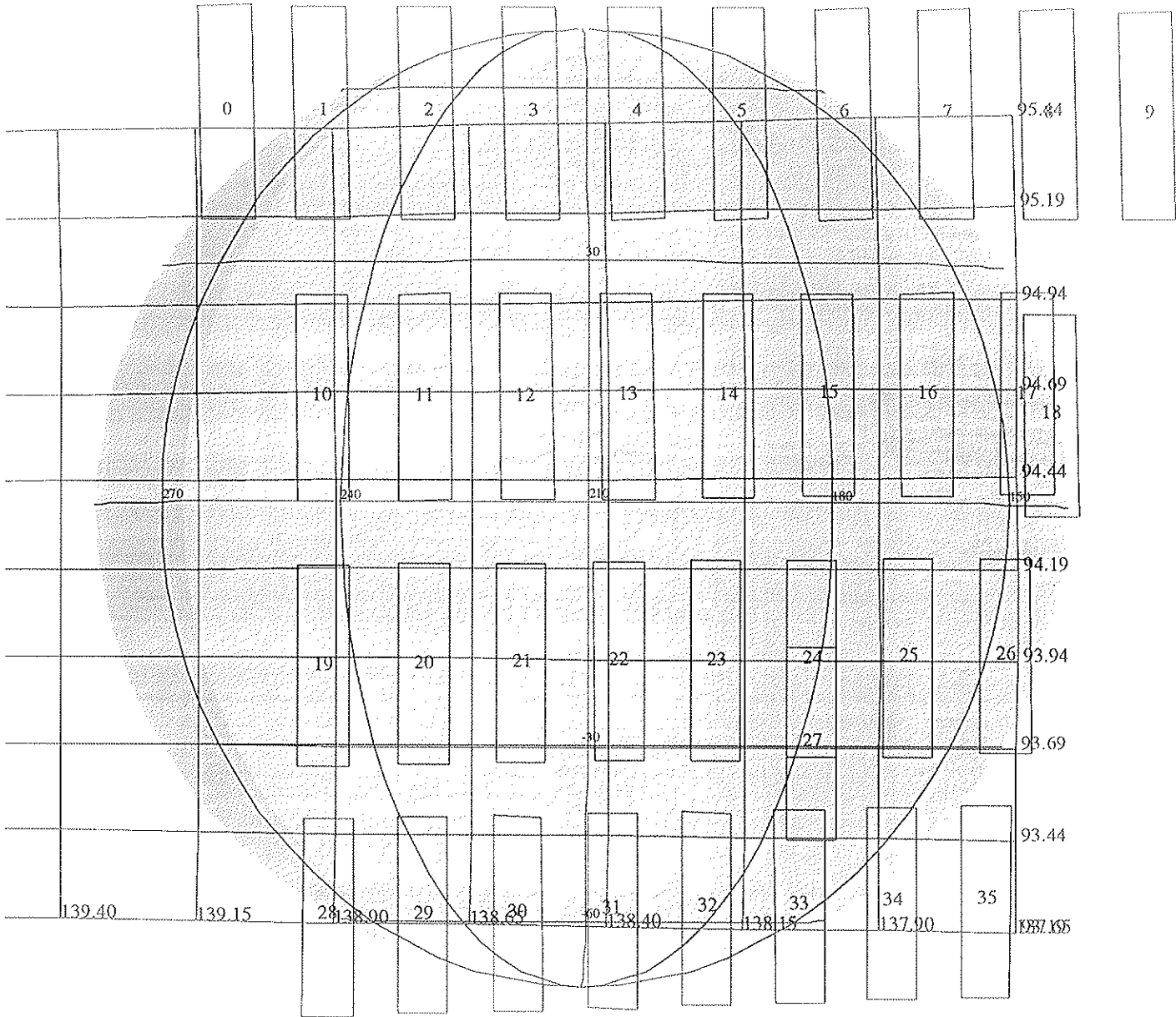

165DV:TT= 0 TMC= 1 C= 11.30 XC= 13.00 BS=10/3738 TC= 3  
 A= 182 pD= 6552 SR=17.450 RA50=266.55 DEC50=-23.94 cone=139.10 clock= 95.49  
 117DV:#SB= 1 OR= 0.060 RR=12.000 BM=F RC= 1 BS=10/3738  
 1:#s= 4 Cs= -32.25 XCs= 0.00 Cr= 30.40 XCr= -9.00 sD= 1616 rD= 20

ESIGN G2.0 jaiel:12/16/1996 13:55:39

FILE:P.E6ENTERINC01

TARGET BODY : EUROPA

FILE:m.E6ENTERINC01

PH:/DATA/NAVIO/T-961107-TOUR.NS

ERIAPSIS:

THINNING: :UVS 1

TARGET:EEE 97-051/17:03:21.333 -CDS 297:00:0

BODY PLOT TIME:TARGET-TIME D= 6552 S= 0.800

*ELARC  
SEVENTEEN COI*

Frame : 0

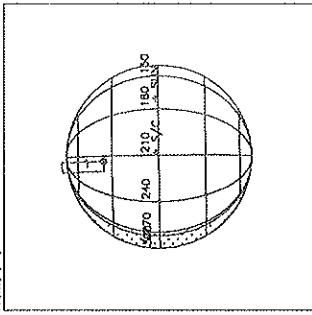

UTC : 1997-051 // 12:06:01.250  
 SCLK: 1/0383689750600

Frame : 1

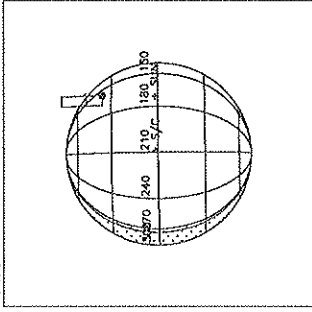

UTC : 1997-051 // 12:09:16.731  
 SCLK: 1/0383689020222

Frame : 2

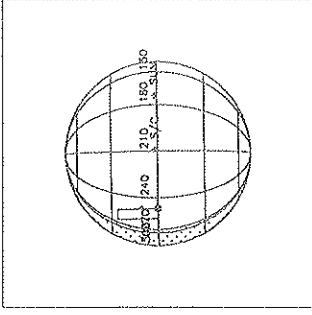

UTC : 1997-051 // 12:12:32.213  
 SCLK: 1/0383689034044

Frame : 3

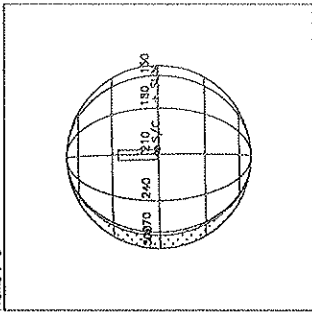

UTC : 1997-051 // 12:15:47.694  
 SCLK: 1/0383689056065

Frame : 4

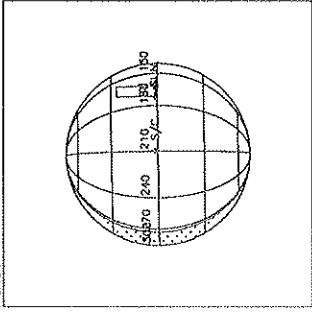

UTC : 1997-051 // 12:19:03.176  
 SCLK: 1/03836890980027

Frame : 5

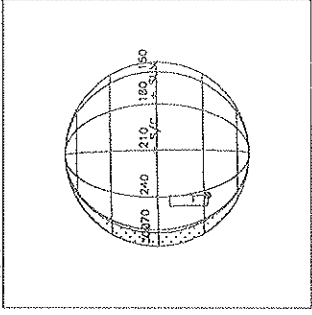

UTC : 1997-051 // 12:22:18.657  
 SCLK: 1/03836891310411

Frame : 6

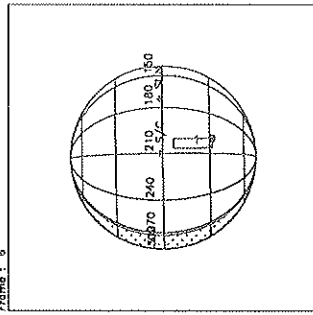

UTC : 1997-051 // 12:25:34.139  
 SCLK: 1/0383689163033

Frame : 7

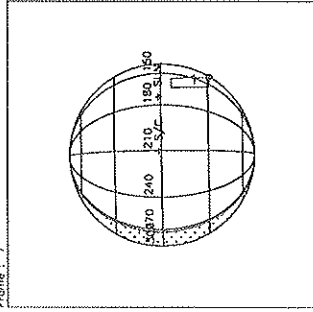

UTC : 1997-051 // 12:28:49.620  
 SCLK: 1/0383689195055

Frame : 8

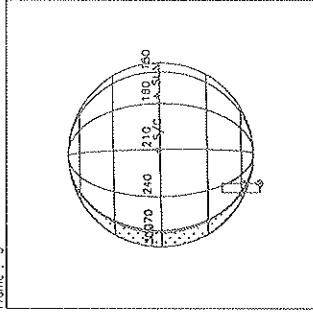

UTC : 1997-051 // 12:32:05.102  
 SCLK: 1/0383689227076

Start UTC.TIME : 1997-051 // 12:06:01.250  
 End UTC.TIME : 1997-051 // 12:35:20.582  
 Start SCLK : 1/03836897-00:0:0  
 Delta Time between FOV : 195.4815  
 FOVs : F\_Channel(0.1x0.4)

Target Body : EUROPA  
 Target Cone/Clock : 138.40/94.31 Deg  
 S/C to Body Center : 100273.0 Km (64.072220 Re.)  
 Z-axis Pointing ( Ra / Dec ) : 130.30 / 18.60 Deg

<b>Activity ID:</b>	Orbit E6	OAPEL EUSUCOMP	<b>SeqNo</b>	01+
<b>Title</b>	Europa Surface Composition		<b>Instrument</b>	UVS
<b>Requestor</b>	UVS-SWG/J. AIELLO X37737	<b>Team</b>	UVS	<b>Working Group</b> SWG
<b>Time System</b>	CDS	<b>Load ID</b>	<b>Calendar Date</b>	02/20/97 <b>Week</b> 8
<b>Start</b>	ETE-CDS 00000056:00:0		97-051/16:06:44.000	ETE-000/00:56:37.333
<b>End</b>	ETE-CDS 00000043:00:0		97-051/16:19:52.667	ETE-000/00:43:28.666
<b>Duration</b>	00000013:00:0		000/00:13:08.667	000/00:13:08.667
<b>Top Label</b>	E6EUSUCOMP01+			
<b>Bottom Label</b>	NIMS ride along			
<b>Plot Key</b>	UVS	<b>Type</b>	SCI	
<b>CDS Bytes</b>	0	<b>Report Options</b>	BOTH	<b>Scan Platform</b> No
<b>CDS Source</b>	OAP	<b>Spin State</b>	DUAL	<b>DMS</b> Yes
<b>Observation Objective</b>				
	Ride along with NIMS surface composition #1.			
	Lat	+25-40		
	Long	130-150		
<b>Design Detail</b>				
CDS	RIM	COMMAND		
28	003	CMDRS		
	004	34UVS,07,SCAN,N,N,N,S,0,ON,OFF,ON,ON,OFF,NOOVR,1,00,9C,01,2C		
	012	34UVS,C1,FIXED,N,N,N,S,0,OFF,OFF,ON,OFF,OFF,NOOVR,1,2C,05,00,00		

9703

96.3

95.8

95.3

94.8

94.3

93.8

93.3

92.85

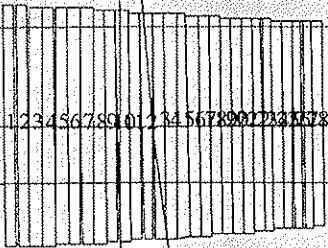

1234567890123456789012345678

134.0

133.5

133.0

132.5

132.0

165DZ:TT= 0 TMC= 1 C= 0.00 XC= 0.00 BS= 0/8328 TC= 1(-20 254 )  
 A= 728 pD= 1456 SR=17.450 RA50=269.54 DEC50=-24.33 cone=132.72 clock= 94.51  
 117DZ:#SB= 1 OR= 0.030 RR=12.000 BM=F RC= 1 BS= 0/8328  
 1:#s= 1 Cs= -14.50 XCs= 0.00 Cr= 19.50 XCr= -8.00 sD= 1456 rD= 24

ESIGN G2.0 jaiel:12/ 2/1996 13:52:47

FILE:P.E6ENSUCOMP01

TARGET BODY: EUROPA

INI:m.E6ENSUCOMP01

PH:/DATA/NAVIO/T-961107-TOUR.NS

ERIAPSIS:

THINNING:NIM 2

TART:ETE 97-051/17:03:24.333 -CDS 52:00:0

BODY PLOT TIME-TARGET-TIME D= 1456 S= 3.000



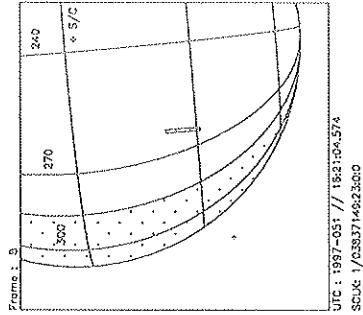
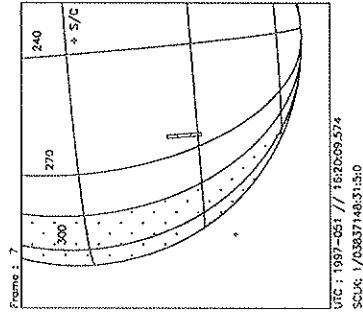
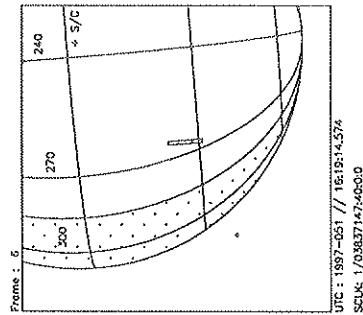
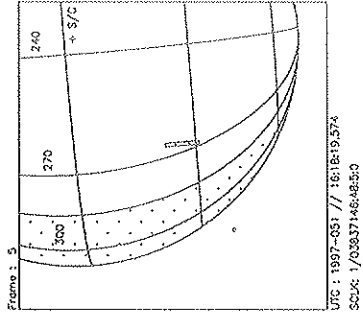
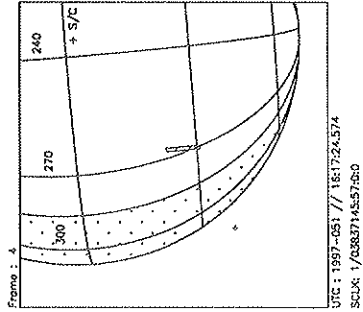
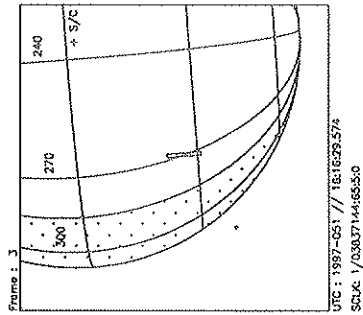
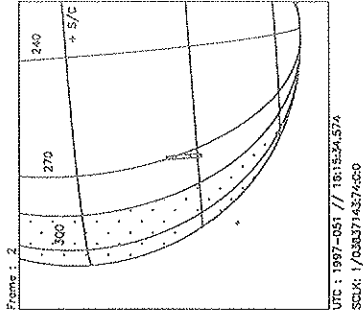
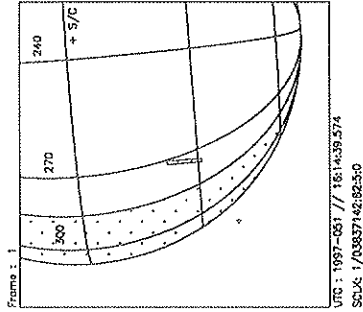
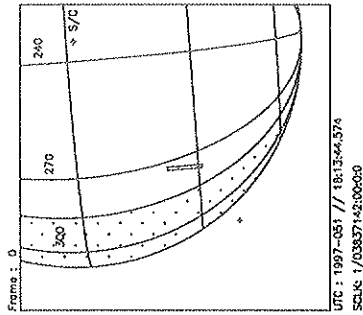

Start UTC\_TIME : 1997-051 // 16:13:44.574  
 No End Time :  
 Start SCLK : 1/03837142:00:00

Target Body : EUROPA  
 Target Cone/Clock : 130.51 / 96.97 Deg  
 S/C to Body Center : 16246.14 Km ( 10.382198 Re )  
 Z-axis Pointing ( Ra / Dec ) : 130.30 / 18.80 Deg

<b>Activity ID:</b>	Orbit E6	<b>OAPEL</b> EUSUCOMP	<b>SeqNo</b>	02+
<b>Title</b>	EUROPA SURFACE COMPOSITION 2		<b>Instrument</b>	UVS
<b>Requestor</b>	UVS-SWG/J. AIELLO X37737	<b>Team</b>	UVS	<b>Working Group</b> SWG
<b>Time System</b>	CDS	<b>Load ID</b>	<b>Calendar Date</b>	02/20/97 <b>Week</b> 8
<b>Start</b>	ETE-CDS 00000038:00:0		97-051/16:24:56.000	ETE-000/00:38:25.333
<b>End</b>	ETE-CDS 00000026:00:0		97-051/16:37:04.000	ETE-000/00:26:17.333
<b>Duration</b>	00000012:00:0		000/00:12:08.000	000/00:12:08.000
<b>Top Label</b>	E6EUSUCOMP02+			
<b>Bottom Label</b>	NIMS ride along			
<b>Plot Key</b>	UVS	<b>Type</b>	SCI	
<b>CDS Bytes</b>	0	<b>Report Options</b>	BOTH	<b>Scan Platform</b> No
<b>CDS Source</b>	OAP	<b>Spin State</b>	DUAL	<b>DMS</b> Yes
<b>Observation Objective</b>				
	Ride along with NIMS surface composition #2.			
	Lat:	-20-40		
	Long:	200-215		
<b>Design Detail</b>				
CDS	RIM	COMMAND		
---	---	-----		
28	003	CMDRS		
	004	34UVS,07,SCAN, N,N,N,S,0, ON,OFF,ON, ON,OFF,NOOVR,1,00,9C,01,2C		
	012	34UVS,C1,FIXED,N,N,N,S,0,OFF,OFF,ON,OFF,OFF,NOOVR,1,2C,05,00,00		

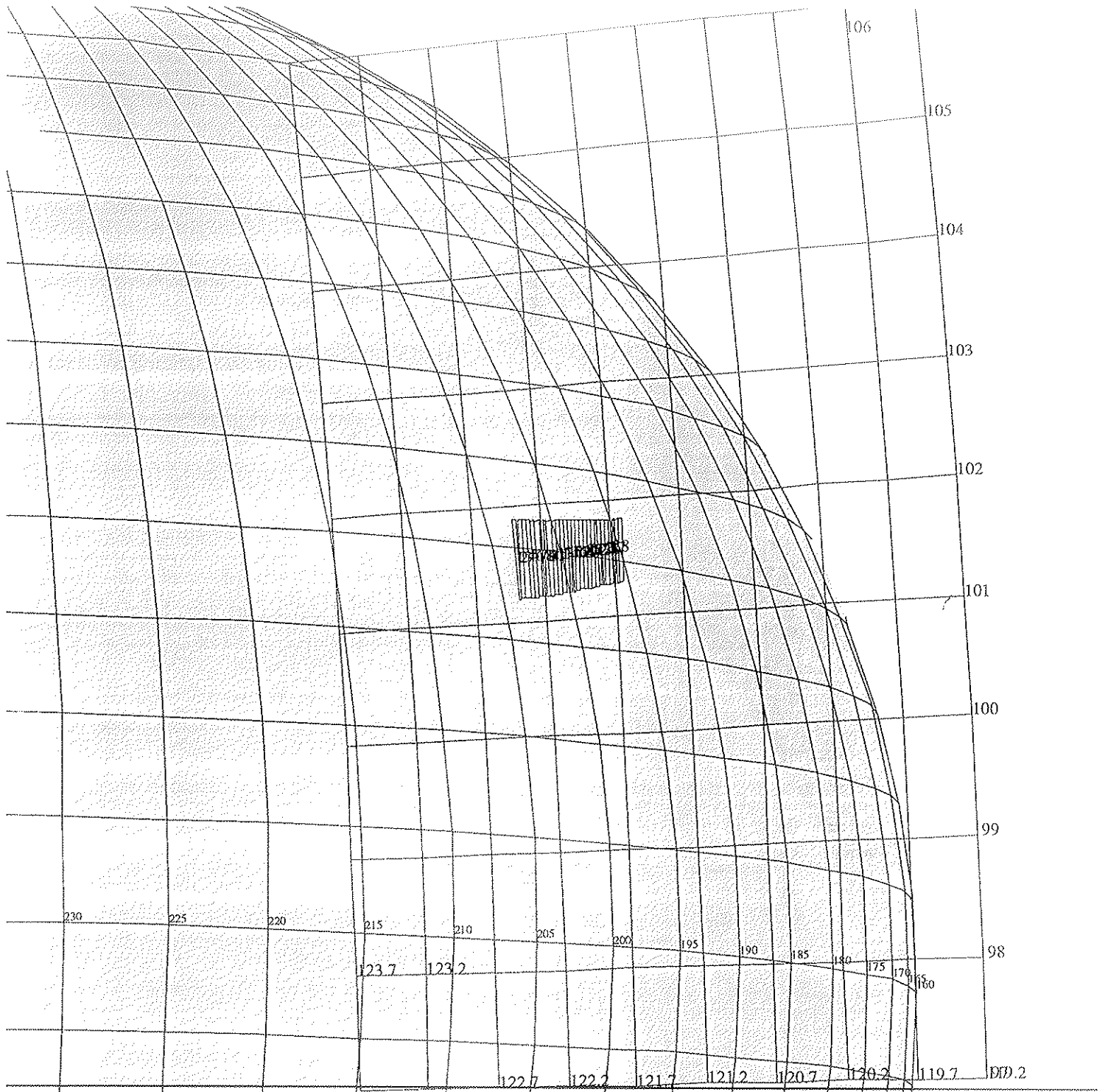

165EA:TT= 0 TMQ= 1 C= 0.00 XC= 0.00 BS= 0/1604 TC= 1(193 203.5 )  
 A=728 pD= 1456 SR=17.450/RA50=249.36 DEC50=-17.41 cone=122.36 clock=101.54  
 117EA:SB= 1 OR= 0.030 RR=12.000 BM=F RC= 1 BS= 0/1604  
 1:fs= 1 Cs= -14.50 XCs= 0.00 Cr= 19.50 XCr= -8.00 sD= 1456 rD= 24

ESIGN G2.0 jael:12/ 2/1996 13:51:53

ILE:P.E6ENSUCOMP02

ARGET BODY : EUROPA

INI:m.E6ENSUCOMP02

PH:/DATA/NAVIO/T-961107-TOUR.NS

ERIAPSIS:

TART:ETE 97-051/17:03:21.333 -CDS 34:00:0

THINNING:NIM 2

BODY PLOT TIME:TARGET-TIME D= 1456 S= 2.000

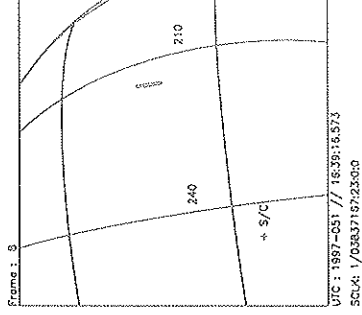
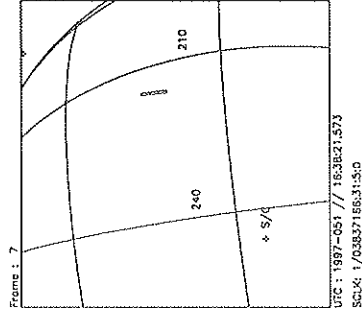
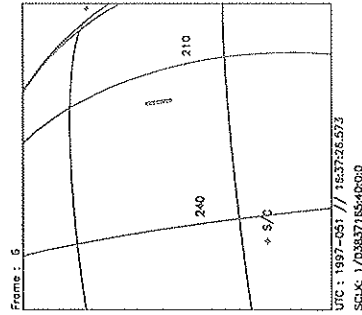
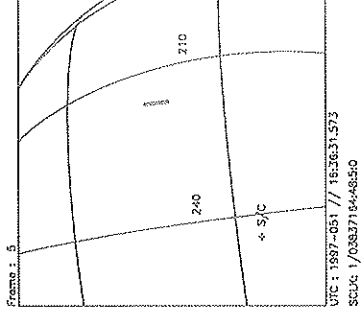
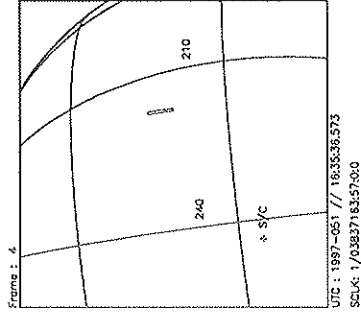
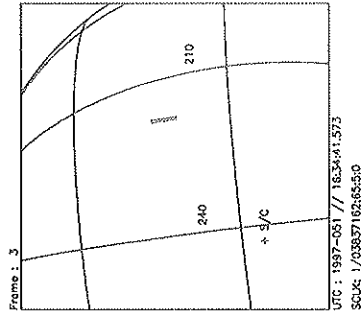
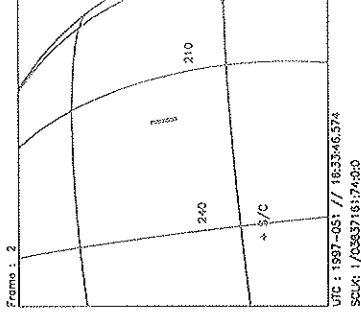
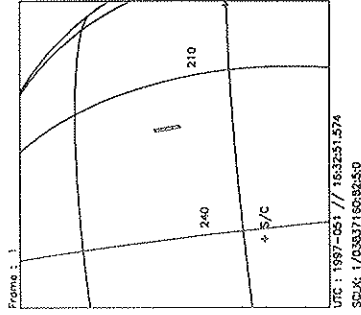
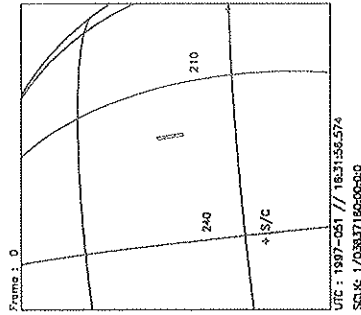

Start UTC\_TIME : 1997-051 // 16:31:56.574  
No End Time ;  
Start SCLK : 1/03837160:00:00

Target Body : EUROPA  
Target Cone/Clock : 125.99 / 98.47 Deg  
S/C to Body Center : 10298.48 Km ( 6.5804975 Re )  
Z-axis Pointing ( Ra / Dec ) : 130.30 / 18.80 Deg